



2023-JULY

**INTERLINKS**  
CREATIVE SOLUTIONS



**LINKS' Creative Solutions ... The Industry Leader!**



The creative furniture solutions you purchase from Links Contract Furniture Inc. are manufactured in a compliant workplace in accordance to ANSI/BIFMA x5.5-2008. Links Contract Furniture Inc. is also Greenguard Certified. Our locally manufactured Melamine is CARB Phase 2 compliant. It can achieve up to 6 LEED credits in the U.S. Green Building Council's leadership in energy and environmental design rating system for environmentally sound construction projects. Contact our Customer Service Personnel for additional details.

Head Office/Showroom:  
Local & International:  
Toll Free - North America:  
Email:  
Website:

141 Cidermill Ave, Unit #1  
P: 416.745.8910  
P: 855-50-LINKS (855.505.4657)  
info@linkscontract.com  
linkscontract.com

Concord, Ontario Canada L4K4G5

- 2 Product, Limited Lifetime Warranty**
- 4 Made-to-Measure
- 6 Specifications
  
- 8 Assembled Components**
  
- 12 Desks, Work Surfaces**
- 14 Bowed Desks
- 17 Executive Work Surfaces
- 18 Shaped Tables (Islands)
  
- 33 Corner Units**
- 40 Multi Dimensional Corner Units - (COR)
- 42 Angled Corner Units - (ACU)
- 48 Extended Corner Units - (ECU)
  
- 57 Hutches**
- 61 Freestanding Hutch Additions, Paper Managers
- 63 Wall Mounted Hutches
- 65 Post Mounted Hutch
- 66 Hutch Door Kits, Optional Locks
- 70 Tack Boards
- 72 Desk Organizers, Hutch Mail Sorters
  
- 74 Mail Sorter Cabinets, Lateral Files**
- 76 Pedestals
- 78 Worksurfaces, Cabinets and Credenzas
- 82 Cabinets and Bookcases
- 100 Corner Cabinets
  
- 102 Divider Panel Sets and Components**
- 108 Reception Centers / Transaction Sets
  
- 112 Half Round/Meeting Tables, Lecturn**
- 114 Tables
- 116 Table Tops
- 118 Table Bases
- 123 Worksurface Supports, Desk Components
  
- 126 Keyboards, Accessories**
- 130 Power Distribution Components
- 132 Power/Data Center, Grommet Placement Options
  
- 134 Terms and Conditions**
- 136 Links Contract Furniture at a glance





## LINKS product guide

### CODE

ACC	Accessories
ACU	Angled Corner Unit
APS	Angled Panel Set
ASM	Assembled
ATS	Angled Corner Transaction Set
BKC	Bookcase
CAB	Cabinet
CPS	Corner Panel Set
CTS	Corner Transaction Set
COR	Corner Unit
DIV	Divider
DKT	Door Kit
DSK	Desk
DTI	D Top Island
ECU	Extended Corner Unit
ELE	Electrical
ETS	Elliptical Transaction Set
FTI	F Top Island
GTI	G Top Island
HUT	Hutch
JTI	J Top Island
LPS	Linear Panel Set
LTI	L Top Island
LTS	Linear Transaction Set
PMHT	Post Mounted Hutch
PST	Post
PTI	P Top Island
QTI	Q Top Island
QTS	Quad Transaction Set
RTI	R Top Island
RTS	Rounded Transaction Set
SOR	Desk Organizer
STI	S Top Island
TB	Tackboard
TBL	Table
TIL	Panel Inserts
VTI	V Top Island
WMHT	Wall Mounted Hutch

Suggested ordering code:

Qty	Code	Top Color	Base Color	Description
1	DSK-2436-LL	CO	BK	DESK



Links Contract Furniture Inc warrants to their authorized dealer, or the original purchaser that all manufactured products are free from defects in materials and workmanship for the life of the product to the original purchaser.

Links Contract Furniture Inc. agrees to repair and or replace any component which upon inspection proves to be original, unaltered and defective upon proof of purchase (which is to include the original invoice from the authorized dealer). This document is the only proof of purchase that Links Contract Furniture Inc. will accept in order to proceed with any claim.

Links Contract Furniture Inc. obligation under this warranty is limited to the replacement cost of parts. Links Contract Furniture Inc. will not be liable for consequential or incidental damages that may arise from a claim of defective workmanship, components and product.

Links Contract Furniture Inc. warranty does not apply to products affected as a result of any form of neglect, alteration, customization, nominal or normal wear and tear, color-fastness or matching of colors, or damage caused by storage, mishandling, intentional abuse, fire, flood, transportation, natural disaster, or any application to which the furniture was not clearly intended, or use and installation other than in accordance with written instructions or warning. Links Contract Furniture Inc. warranty does not apply to natural variations in wood or other materials and these variations will not be considered defects by manufacturer.

Links Contract Furniture Inc. warranty does not extend to labor, delivery, and/or to installation costs and applies only to the United States and Canada.

Links Contract Furniture Inc. warranty is for normal commercial use only and does not apply for products used for rental purposes.



## MADE-TO-MEASURE AT NO UPCHARGE PROGRAM

The Made-to-Measure at No Upcharge program **excludes** pedestals, lateral files, cabinets with drawers, bookcases and boardroom tables. For additional custom products please contact your customer service representative for pricing.



Links Contract Furniture Inc. Made to Measure program offers office furniture to suit your office space at no upcharge. This program applies to all worksurfaces and overhead storage.

For example: 72" x 30" too large for your space, you need a 68" x 29", no problem.

Use the 72" x 30" (which is the next size up, list price) and we will produce your required size at NO UPCHARGE.



How the Made-To-Measure program works:

1. Select any standard worksurface or overhead storage unit from our price list.
2. Re-size the unit to your required specification.
3. Select the "next size up" standard unit in our price list, this is your list price. "No additional upcharge will apply".
4. Specify product as "Special Size".

### Worksurfaces and Side Panels (Gables)

- Worksurfaces are 1" (25mm). Side panels are 1" (25mm) thick solid CARB 2 core 45 pound density particle board, finished on both sides with thermofused laminate, offering premium quality abrasion and stain resistant surfaces.
- Worksurfaces and Side Panels edged on all 4 sides.
- Worksurfaces have pre-drilled anchor holes to accept privacy panels.
- Edges are user friendly, 3mm thick "Tough Guard" edged; beveled edges improve user comfort and product durability.
- Side Panels are edged on bottom for additional strength and to seal out moisture.
- Side panels are pre-drilled in "non-handed" design to allow for reconfigurations.
- Leveler shape is square body with rounded bottom, allowing for easy leveling of units.
- The floor levelers offer additional space between side panels and floor, minimizing moisture from carpet or floor damaging side panels.
- Floor levelers plastic base is 5/8" (16mm) high, with 1 1/4" (32mm) high threaded stem allowing 1" (25mm) height adjustment.

### Back Panels

- 5/8" (16mm) thick solid core 45 pound density particle board, finished on both sides with thermofused laminate.
- Standard full height back panel.
- 3/4 height back panel, 18" (455 mm) **(SM)**.
- 1/4 height back panel, 10" (254 mm) **(MM)**.
- Flush to back, back panel unless otherwise indicated.

### Pedestals and Drawers

- Drawer fronts are 5/8" (16mm) thick solid core particle board finished on both sides with thermofused laminate.
- Drawer fronts have 3mm thick "Tough Guard" edging on all 4 sides.
- Five sided drawer construction offers strength and durability.
- Interior drawer construction in black finish.
- Pedestal drawers open with side pull, located on user side.
- Lateral file drawers, open with front pull handles.
- Pull handles are drilled 128mm apart, allowing for a wide comfortable grip.
- Box drawers, File drawers, and Lateral file drawers, operate on ball bearing suspension slides for smooth and quiet operation.
- Box drawers operate on full extension ball-bearing slides, tested for 75lbs. / 34kg.
- File drawers operate on full extension ball bearing slides, tested for 100lbs. / 45kg.
- Lateral file drawers operate on full extension ball bearing slides, tested for 150lbs. / 68kg.
- Box drawer is standard with molded plastic pencil tray (one per unit).
- File drawers and Lateral file drawers are standard with file support rails, accepting letter or legal hanging files, allowing front to back or side to side filing.
- Lateral files drawers interlocking system, standard on 3 drawer, 4 drawer, optional on 2 drawer models.
- The interlocking system allows only one drawer to be opened at a time.
- Box drawers and file drawers are 18" (457mm) depth.
- Non-handed.

### Doors

- Laminated doors are 5/8" (16mm) thick solid core particle board finished on both sides with thermofused laminate.
- Laminated doors have 3mm thick "Tough Guard" edging on all 4 sides.
- Glazed doors are standard in 5/8" (16mm) thick framed exterior with frosted glazed interior.
- Glazed doors are finished on both the front and back for a fully finished appearance.
- Cabinet and hutch doors operate on self closing hinges for smooth and quiet operation.
- Laminated storage cabinet doors, open with front pull handles.
- Hutch doors are available in hinged and flip-up options.
- Laminate and glazed doors are interchangeable.
- Doors are standard with 35mm half overlay and 40mm full overlay clip on hinges.

### Edge Specifications

- All edges are "Tough Guard", scuff resistant, 3mm thick beveled edging.
- 3mm thick edge is applied to components using state-of-the-art automated machinery ensuring a permanent bond.

### Lock Specifications

- Locks are standard with an interchangeable lock core.
- Locks are standard in black and silver finishes.
- Locks are standard with collapsible key preventing damage to key.
- Lock core can be changed allowing multiple units to be keyed alike.
- Lock core can be changed allowing multiple units in a common area to be keyed differently (50 different cores available).
- One lock is standard on Box/File Pedestals, locking Box/File Drawers.
- One lock is standard on Box/Box/File Pedestals, locking Box/Box/File Drawers.
- One lock is standard on File/File Pedestals, locking File/File Drawers.
- Locking doors on selected cabinets, locks are standard on lateral files.
- Identical lock numbers are automatically supplied on the same unit.
- Core removable key available, master key available.
- Keys supplied with Microban Antimicrobial product protection
- Optional locks available on Hutches

### Hutch Attachment Specifications

- Hutch mounts onto base units without mechanical fasteners, two sided "Velcro" strips are provided allowing installer to attach hutch to base units.
- Post mounted hutches attach to worksurface aluminum posts.
- Wall mounted storage cabinets are standard with z-bar bracket attachment for accurate and sturdy installation.

### Privacy Panels and Transaction Sets

- 2" (51mm) aluminum posts available in 6", 12", 18", 24", and 36" height, black or brushed aluminum .
- Divider panel inserts available in 5/8" thick laminate, 5/8" glazed (ribbed polycarbonate) smoked finish or crystal finish, 5/8" fabric tackable, 5/8" whiteboard, 5/8" slatwall, and 5/8" frosted.
- 1" thick (25mm) transaction counter mounted to posts with flush metal plates, rectangular corners, racetrack, and elliptical shapes.



**Grommets**

- Center grommet is standard on all desks, corner units, extended corner units, and selected shaped worksurfaces and cabinets. Black or Silver

**Power/Data Center**

- Optional Mini-Port Power Data Center that can be installed on any worksurface.
- Pak8 systems power distribution components.

**Packaging**

- Assembled units are packaged in corrugated cartons containing high recycled content.
- Worksurface edges and corners are reinforced with edge and corner protectors.
- Wood strapping supports the bottom portion of assembled units.

**Thickness**

- Worksurfaces: 1" (25mm) thick.
- Side Panels (Gables): 1" (25mm) thick.
- Back Panels: 5/8" (16mm) thick.
- Drawer Fronts: 5/8" (16mm) thick.
- Doors: 5/8" (16mm) thick.

**Industry Standards**

- Components meet current ANSI/BIFMA Standards, Greenguard Certified.

**Sizes and Weights**

- Weights are approximate and are not exact.
- Height does not include floor levelers. (some exceptions apply to height)

**Finishes / Color Specifications**

- Unit color may be ordered one-tone or two-tone.
- You may select one color worksurface/drawer/door fronts and another color base.

**To Specify one-tone or two-tone colors:**

- First code denotes the worksurface/drawer/door/shelf color, second code denotes the base color.
- To order one-tone color units, specify worksurface and base code identically. **i.e. CO/CO or CO - Cognac top with Cognac base.**
- To order two-tone color units, specify worksurface and base code separately. **i.e. CO/SA - Cognac top and fronts with Sahara base.**

**Available Laminate Finishes:**

- |              |                       |               |                       |
|--------------|-----------------------|---------------|-----------------------|
| <b>TOPS:</b> | Nutmeg (NM)           | <b>BASES:</b> | Nutmeg (NM)           |
|              | Chocolate Walnut (CW) |               | Chocolate Walnut (CW) |
|              | Cherry Henna (CH)     |               | Cherry Henna (CH)     |
|              | Cognac (CO)           |               | Cognac (CO)           |
|              | Sahara (SA)           |               | Sahara (SA)           |
|              | Riviera Maple (RM)    |               | Riviera Maple (RM)    |
|              | Willow Gray (WG)      |               | Willow Gray (WG)      |
|              | True White (TW)       |               | True White (TW)       |
|              | Storm Gray (SG)       |               | Storm Gray (SG)       |
|              | Cappuccino (CP)       |               | Chamois Black (BK)    |
|              | Gray (GR)             |               | Cappuccino (CP)       |
|              | Milky Way (MW)        |               | Gray (GR)             |
|              | London Fog (LN)       |               | Milky Way (MW)        |
|              | Windy City (WC)       |               | London Fog (LN)       |
|              | Aspen (AP)            |               | Windy City (WC)       |
|              | Sesame (SS)           |               | Aspen (AP)            |
|              | Caraway (CY)          |               | Sesame (SS)           |
|              |                       |               | Caraway (CY)          |

**ACCENTS (Door/Drawer Fronts, Shelves):**

- Lime Burst (LB)
- Aqua Breeze (AB)
- Strawberry Fields (SF)

**Pull Handle Options**



**STANDARD "P1" PULL HANDLE**  
Black Finish



**Optional "P2" PULL HANDLE**  
Silver Finish



**Optional "P3" PULL HANDLE**  
Silver Finish



**Optional "P4" PULL HANDLE**  
Silver Finish



**Optional "P5" PULL HANDLE**  
Brushed Nickel Finish



**Optional "P6" PULL HANDLE**  
Matte Black Finish



**Optional "P7" PULL HANDLE**  
Brushed Nickel Finish

All above handles are for use with: lateral files, storage cabinets and other items, such as serving carts and wardrobes, manufactured by Links Contract Furniture Inc.. Please specify the handle of your choice on your purchase order. Orders will be processed with the standard P1 handle if not specified on your order.

**Notification:**

We are constantly upgrading our products. For the most up-to date product specifications, please contact Customer Service.

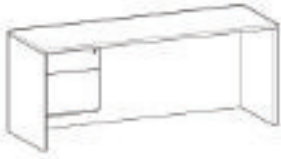

Single Left Box/File Pedestal Desk. 20"D and 24"D with full back panel.

30"D and 36"D with full recessed back panel.

CODE	PRICE	WIDTH (in/mm)	DEPTH (in/mm)	HEIGHT (in/mm)	VOLUME (ft3/m3)	WEIGHT (lbs/kg)
ASM-2072-LBF	1061	72/1829	20/508	29/737	30/0.85	180/82
ASM-2472-LBF	1074	72/1829	24/610	29/737	33/0.93	190/86
ASM-3060-LBF	1084	60/1524	30/762	29/737	34/0.96	185/84
ASM-3066-LBF	1171	66/1676	30/762	29/737	37/1.05	195/88
ASM-3072-LBF	1270	72/1829	30/762	29/737	42/1.19	215/98
ASM-3672-LBF	1288	72/1829	36/914	29/737	49/1.39	235/107

add -P 56 with handles



Single Left Box/Box/File Pedestal Desk. 20"D and 24"D with full back panel.

30"D and 36"D with full recessed back panel.

ASM-2072-LBBF	1308	72/1829	20/508	29/737	30/0.85	205/93
ASM-2472-LBBF	1320	72/1829	24/610	29/737	33/0.93	215/98
ASM-3060-LBBF	1330	60/1524	30/762	29/737	34/0.96	205/93
ASM-3066-LBBF	1420	66/1676	30/762	29/737	37/1.05	215/98
ASM-3072-LBBF	1514	72/1829	30/762	29/737	42/1.19	235/107
ASM-3672-LBBF	1536	72/1829	36/914	29/737	49/1.39	255/116

add -P 84 with handles

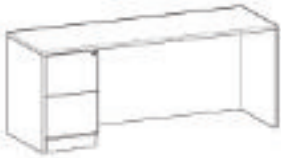

Single Left File/File Pedestal Desk. 20"D and 24"D with full back panel.

30"D and 36"D with full recessed back panel.

ASM-2072-LFF	1308	72/1829	20/508	29/737	30/0.85	205/93
ASM-2472-LFF	1320	72/1829	24/610	29/737	33/0.93	215/98
ASM-3060-LFF	1330	60/1524	30/762	29/737	34/0.96	205/93
ASM-3066-LFF	1420	66/1676	30/762	29/737	37/1.05	215/98
ASM-3072-LFF	1514	72/1829	30/762	29/737	42/1.19	235/107
ASM-3672-LFF	1536	72/1829	36/914	29/737	49/1.39	255/116

add -P 56 with handles

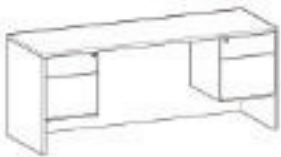

Double Pedestal Desk. 20"D and 24"D with full back panel.

30"D and 36"D with full recessed back panel.

ASM-2072-DBFBF	1328	72/1829	20/508	29/737	30/0.85	205/93
ASM-2472-DBFBF	1342	72/1829	24/610	29/737	33/0.93	215/98
ASM-3060-DBFBF	1379	60/1524	30/762	29/737	34/0.96	230/104
ASM-3066-DBFBF	1466	66/1676	30/762	29/737	36/1.02	240/109
ASM-3072-DBFBF	1487	72/1829	30/762	29/737	42/1.19	260/118
ASM-3672-DBFBF	1504	72/1829	36/914	29/737	49/1.39	280/127

add -P 112 with handles

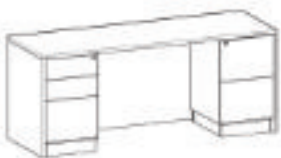

Double Pedestal Desk. 20"D and 24"D with full back panel.

30"D and 36"D with full recessed back panel.

ASM-2072-DBBF-FF	1820	72/1829	20/508	29/737	30/0.85	250/113
ASM-2472-DBBF-FF	1835	72/1829	24/610	29/737	33/0.93	260/118
ASM-3060-DBBF-FF	1870	60/1524	30/762	29/737	34/0.96	270/122
ASM-3066-DBBF-FF	1960	66/1676	30/762	29/737	37/1.05	280/127
ASM-3072-DBBF-FF	1978	72/1829	30/762	29/737	42/1.19	300/136
ASM-3672-DBBF-FF	1997	72/1829	36/914	29/737	49/1.39	320/145

add -P 140 with handles

For additional specification instructions see page 6.

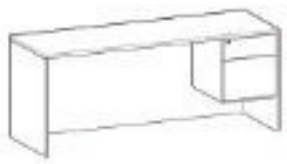

Single Right Box/File Pedestal Desk. 20"D and 24"D with full back panel.

30"D and 36"D with full recessed back panel.

CODE	PRICE	WIDTH (in/mm)	DEPTH (in/mm)	HEIGHT (in/mm)	VOLUME (ft3/m3)	WEIGHT (lbs/kg)
ASM-2072-RBF	1061	72/1829	20/508	29/737	30/0.85	180/82
ASM-2472-RBF	1074	72/1829	24/610	29/737	33/0.93	190/86
ASM-3060-RBF	1084	60/1524	30/762	29/737	34/0.96	185/84
ASM-3066-RBF	1171	66/1676	30/762	29/737	37/1.05	195/88
ASM-3072-RBF	1270	72/1829	30/762	29/737	42/1.19	215/98
ASM-3672-RBF	1288	72/1829	36/914	29/737	49/1.39	235/107

add -P 56 with handles

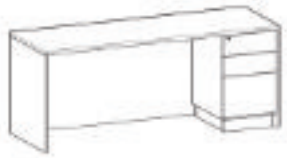

Single Right Box/Box/File Pedestal Desk. 20"D and 24"D with full back panel.

30"D and 36"D with full recessed back panel.

ASM-2072-RBBF	1308	72/1829	20/508	29/737	30/0.85	205/93
ASM-2472-RBBF	1320	72/1829	24/610	29/737	33/0.93	215/98
ASM-3060-RBBF	1330	60/1524	30/762	29/737	34/0.96	205/93
ASM-3066-RBBF	1420	66/1676	30/762	29/737	37/1.05	215/98
ASM-3072-RBBF	1514	72/1829	30/762	29/737	42/1.19	235/107
ASM-3672-RBBF	1536	72/1829	36/914	29/737	49/1.39	255/116

add -P 84 with handles

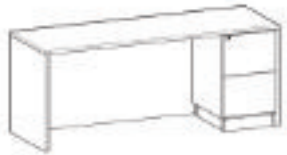

Single Right File/File Pedestal Desk. 20"D and 24"D with full back panel.

30"D and 36"D with full recessed back panel.

ASM-2072-RFF	1308	72/1829	20/508	29/737	30/0.85	205/93
ASM-2472-RFF	1320	72/1829	24/610	29/737	33/0.93	215/98
ASM-3060-RFF	1330	60/1524	30/762	29/737	34/0.96	205/93
ASM-3066-RFF	1420	66/1676	30/762	29/737	37/1.05	215/98
ASM-3072-RFF	1514	72/1829	30/762	29/737	42/1.19	235/107
ASM-3672-RFF	1536	72/1829	36/914	29/737	49/1.39	255/116

add -P 56 with handles



Connecting Top Full Back Panel with Grommet.

Shipped K.D.

ASM-2042-CT	478	42/1067	20/508	29/737	4/0.11	71/32
ASM-2048-CT	512	48/1219	20/508	29/737	4/0.11	83/38
ASM-2442-CT	502	42/1067	24/610	29/737	4/0.11	73/33
ASM-2448-CT	536	48/1219	24/610	29/737	4/0.11	85/39



"D" Shape Top with End Panel, Grommet and single post leg.

"C1" - Black Post Leg  
"C3" - Silver Post Leg

Shipped K.D.

ASM-3672-DTWPC1	934	72/1829	36/914	29/737	5/0.14	78/35
ASM-3672-DTWPC3	934	72/1829	36/914	29/737	5/0.14	78/35

For additional specification instructions see page 6.



Left (Links-Right) Executive Return with Grommet.

Shipped K.D.

CODE	PRICE	WIDTH (in/mm)	DEPTH (in/mm)	HEIGHT (in/mm)	VOLUME (ft <sup>3</sup> /m <sup>3</sup> )	WEIGHT (lbs/kg)
ASM-2042-LROP	608	42/1067	20/508	29/737	3/0.08	78/35
ASM-2048-LROP	632	48/1219	20/508	29/737	4/0.11	88/40
ASM-2442-LROP	620	42/1067	24/610	29/737	3/0.08	80/36
ASM-2448-LROP	644	48/1219	24/610	29/737	4/0.11	90/41



Left Box/File (Links-Right) Executive Return with Grommet

ASM-2042-LRBF	857	42/1067	20/508	29/737	15/0.42	123/56
ASM-2048-LRBF	876	48/1219	20/508	29/737	22/0.62	133/60
ASM-2442-LRBF	871	42/1067	24/610	29/737	15/0.42	125/57
ASM-2448-LRBF	890	48/1219	24/610	29/737	22/0.62	135/61

add -P 56 with handles



Left Box/Box/File (Links-Right) Executive Return with Grommet

ASM-2042-LRBFF	1103	42/1067	20/508	29/737	15/0.42	143/65
ASM-2048-LRBFF	1123	48/1219	20/508	29/737	22/0.62	153/69
ASM-2442-LRBFF	1118	42/1067	24/610	29/737	15/0.42	145/66
ASM-2448-LRBFF	1139	48/1219	24/610	29/737	22/0.62	155/70

add -P 84 with handles



Left File/File (Links-Right) Executive Return with Grommet

ASM-2042-LRFF	1103	42/1067	20/508	29/737	15/0.42	143/65
ASM-2048-LRFF	1123	48/1219	20/508	29/737	22/0.62	153/69
ASM-2442-LRFF	1118	42/1067	24/610	29/737	15/0.42	145/66
ASM-2448-LRFF	1139	48/1219	24/610	29/737	22/0.62	155/70

add -P 56 with handles

For additional specification instructions see page 6.

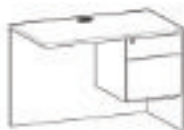

			WIDTH	DEPTH	HEIGHT	VOLUME	WEIGHT
	CODE	PRICE	(in/mm)	(in/mm)	(in/mm)	(ft3/m3)	(lbs/kg)
 <p>Right (Links-Left) Executive Return with Grommet. Shipped K.D.</p>	ASM-2042-RRBP	608	42/1067	20/508	29/737	3/0.08	78/35
	ASM-2048-RRBP	632	48/1219	20/508	29/737	4/0.11	88/40
	ASM-2442-RRBP	620	42/1067	24/610	29/737	3/0.08	80/36
	ASM-2448-RRBP	644	48/1219	24/610	29/737	4/0.11	90/41

 <p>Right Box/File (Links-Left) Executive Return with Grommet</p>	ASM-2042-RRBF	857	42/1067	20/508	29/737	15/0.42	123/56
	ASM-2048-RRBF	876	48/1219	20/508	29/737	22/0.62	133/60
	ASM-2442-RRBF	871	42/1067	24/610	29/737	15/0.42	125/57
	ASM-2448-RRBF	890	48/1219	24/610	29/737	22/0.62	135/61
	add -P	56	with handles				

 <p>Right Box/Box/File (Links-Left) Executive Return with Grommet</p>	ASM-2042-RRBBF	1103	42/1067	20/508	29/737	15/0.42	143/65
	ASM-2048-RRBBF	1123	48/1219	20/508	29/737	22/0.62	153/69
	ASM-2442-RRBBF	1118	42/1067	24/610	29/737	15/0.42	145/66
	ASM-2448-RRBBF	1139	48/1219	24/610	29/737	22/0.62	155/70
	add -P	84	with handles				

 <p>Right File/File (Links-Left) Executive Return with Grommet</p>	ASM-2042-RRFF	1103	42/1067	20/508	29/737	15/0.42	143/65
	ASM-2048-RRFF	1123	48/1219	20/508	29/737	22/0.62	153/69
	ASM-2442-RRFF	1118	42/1067	24/610	29/737	15/0.42	145/66
	ASM-2448-RRFF	1139	48/1219	24/610	29/737	22/0.62	155/70
	add -P	56	with handles				

For additional specification instructions see page 6.

**Links-Free (DSK) - LF**



Desk with 24"D or 30"D work surface, two full non-connected links free side panels. Includes grommet.

CODE	PRICE	WIDTH (in/mm)	DEPTH (in/mm)	HEIGHT (in/mm)	VOLUME (ft3/m3)	WEIGHT (lbs/kg)
24"D work surface	DSK-2424-LF	511	24/610	24/610	29/737	3/0.08 65/29
	DSK-2430-LF	544	30/762	24/610	29/737	3/0.08 70/32
	DSK-2436-LF	577	36/914	24/610	29/737	3/0.08 79/36
	DSK-2442-LF	611	42/1067	24/610	29/737	3/0.08 85/39
	DSK-2448-LF	642	48/1219	24/610	29/737	4/0.11 93/42
	DSK-2454-LF	673	54/1372	24/610	29/737	4/0.11 100/45
	DSK-2460-LF	706	60/1524	24/610	29/737	5/0.14 107/49
	DSK-2466-LF	739	66/1676	24/610	29/737	5/0.14 115/52
DSK-2472-LF	772	72/1829	24/610	29/737	5/0.14 123/56	
30"D work surface	DSK-3030-LF	623	30/762	30/762	29/737	3/0.08 82/37
	DSK-3036-LF	658	36/914	30/762	29/737	3/0.08 90/41
	DSK-3042-LF	691	42/1067	30/762	29/737	3/0.08 99/45
	DSK-3048-LF	722	48/1219	30/762	29/737	4/0.11 108/49
	DSK-3054-LF	746	54/1372	30/762	29/737	4/0.11 116/53
	DSK-3060-LF	772	60/1524	30/762	29/737	5/0.14 124/56
	DSK-3066-LF	836	66/1676	30/762	29/737	5/0.14 132/60
	DSK-3072-LF	851	72/1829	30/762	29/737	5/0.14 140/64

For optional 3/4 modesty panel (18in / 455mm high) add the suffix SM to the product code. i.e. DSK-2424-LF-SM

For optional 1/4 modesty panel (10in / 254mm high) add the suffix MM to the product code. i.e. DSK-2424-LF-MM

**Links-Left (DSK) - LL**

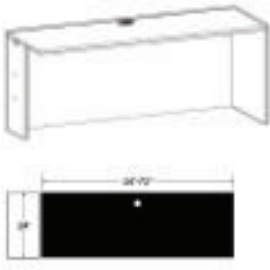

Desk with 24"D or 30"D work surface, full panel on right, narrow connecting panel on left. Links left to connecting 24"D or 30"D work surface. Includes grommet.

24"D work surface	DSK-2424-LL	511	24/610	24/610	29/737	3/0.08 58/26
	DSK-2430-LL	544	30/762	24/610	29/737	3/0.08 63/29
	DSK-2436-LL	577	36/914	24/610	29/737	3/0.08 72/33
	DSK-2442-LL	611	42/1067	24/610	29/737	3/0.08 78/35
	DSK-2448-LL	642	48/1219	24/610	29/737	4/0.11 86/39
	DSK-2454-LL	673	54/1372	24/610	29/737	4/0.11 93/42
	DSK-2460-LL	706	60/1524	24/610	29/737	5/0.14 100/45
	DSK-2466-LL	739	66/1676	24/610	29/737	5/0.14 108/49
DSK-2472-LL	772	72/1829	24/610	29/737	5/0.14 116/53	
30"D work surface	DSK-3030-LL	623	30/762	30/762	29/737	3/0.08 76/34
	DSK-3036-LL	658	36/914	30/762	29/737	3/0.08 82/37
	DSK-3042-LL	691	42/1067	30/762	29/737	3/0.08 91/41
	DSK-3048-LL	722	48/1219	30/762	29/737	4/0.11 100/45
	DSK-3054-LL	746	54/1372	30/762	29/737	4/0.11 108/49
	DSK-3060-LL	772	60/1524	30/762	29/737	5/0.14 116/53
	DSK-3066-LL	836	66/1676	30/762	29/737	5/0.14 124/56
	DSK-3072-LL	851	72/1829	30/762	29/737	5/0.14 132/60

For optional 3/4 modesty panel (18in / 455mm high) add the suffix SM to the product code. i.e. DSK-2424-LL-SM

For optional 1/4 modesty panel (10in / 254mm high) add the suffix MM to the product code. i.e. DSK-2424-LL-MM

For additional specification instructions see page 6. Desk components and extended gables can be found on page 123. Refer to pages 130-131 for electrical options and pages 132-133 for power/data, grommet placement options. See page 126 for keyboards and accessories. Divider panel sets and components available starting on page 102.

Links-Right (DSK) - LR

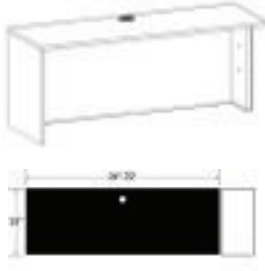

Desk with 24"D or 30"D work surface, full panel on left, narrow connecting panel on right. Links right to connecting 24"D or 30"D work surface. Includes grommet.

CODE	PRICE	WIDTH (in/mm)	DEPTH (in/mm)	HEIGHT (in/mm)	VOLUME (ft3/m3)	WEIGHT (lbs/kg)
24" D work surface	DSK-2424-LR	511	24/610	24/610	29/737	3/0.08 58/26
	DSK-2430-LR	544	30/762	24/610	29/737	3/0.08 63/29
	DSK-2436-LR	577	36/914	24/610	29/737	3/0.08 72/33
	DSK-2442-LR	611	42/1067	24/610	29/737	3/0.08 78/35
	DSK-2448-LR	642	48/1219	24/610	29/737	4/0.11 86/39
	DSK-2454-LR	673	54/1372	24/610	29/737	4/0.11 93/42
	DSK-2460-LR	706	60/1524	24/610	29/737	5/0.14 100/45
30" D work surface	DSK-2466-LR	739	66/1676	24/610	29/737	5/0.14 108/49
	DSK-2472-LR	772	72/1829	24/610	29/737	5/0.14 116/53
	DSK-3030-LR	623	30/762	30/762	29/737	3/0.08 76/34
	DSK-3036-LR	658	36/914	30/762	29/737	3/0.08 82/37
	DSK-3042-LR	691	42/1067	30/762	29/737	3/0.08 91/41
	DSK-3048-LR	722	48/1219	30/762	29/737	4/0.11 100/45
	DSK-3054-LR	746	54/1372	30/762	29/737	4/0.11 108/49
DSK-3060-LR	772	60/1524	30/762	29/737	5/0.14 116/53	
DSK-3066-LR	836	66/1676	30/762	29/737	5/0.14 124/56	
DSK-3072-LR	851	72/1829	30/762	29/737	5/0.14 132/60	

For optional 3/4 modesty panel (18in / 455mm high) add the suffix SM to the product code. i.e. DSK-2424-LR-SM

For optional 1/4 modesty panel (10in / 254mm high) add the suffix MM to the product code. i.e. DSK-2424-LR-MM

Links-Center (DSK) - LC

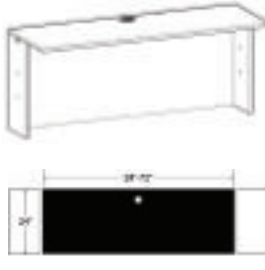

Desk with 24"D or 30"D work surface, two narrow connecting side panels. Links left, right to connecting 24"D or 30"D work surface. Includes grommet.

24" D work surface	DSK-2424-LC	511	24/610	24/610	29/737	3/0.08 51/23
	DSK-2430-LC	544	30/762	24/610	29/737	3/0.08 56/25
	DSK-2436-LC	577	36/914	24/610	29/737	3/0.08 65/29
	DSK-2442-LC	611	42/1067	24/610	29/737	3/0.08 71/32
	DSK-2448-LC	642	48/1219	24/610	29/737	4/0.11 79/36
	DSK-2454-LC	673	54/1372	24/610	29/737	4/0.11 86/39
	DSK-2460-LC	706	60/1524	24/610	29/737	5/0.14 93/42
30" D work surface	DSK-2466-LC	739	66/1676	24/610	29/737	5/0.14 101/46
	DSK-2472-LC	772	72/1829	24/610	29/737	5/0.14 109/49
	DSK-3030-LC	623	30/762	30/762	29/737	3/0.08 68/31
	DSK-3036-LC	658	36/914	30/762	29/737	3/0.08 74/34
	DSK-3042-LC	691	42/1067	30/762	29/737	3/0.08 83/38
	DSK-3048-LC	722	48/1219	30/762	29/737	4/0.11 92/42
	DSK-3054-LC	746	54/1372	30/762	29/737	4/0.11 100/45
DSK-3060-LC	772	60/1524	30/762	29/737	5/0.14 108/49	
DSK-3066-LC	836	66/1676	30/762	29/737	5/0.14 116/53	
DSK-3072-LC	851	72/1829	30/762	29/737	5/0.14 124/56	

For optional 3/4 modesty panel (18in / 455mm high) add the suffix SM to the product code. i.e. DSK-2424-LC-SM

For optional 1/4 modesty panel (10in / 254mm high) add the suffix MM to the product code. i.e. DSK-2424-LC-MM

For additional specification instructions see page 6. Desk components and extended gables can be found on page 123. Refer to pages 130-131 for electrical options and pages 132-133 for power/data, grommet placement options. See page 126 for keyboards and accessories. Divider panel sets and components available starting on page 102.

**Bowed Left Links-Left (DSK) - BW-LL**



Bowed desk with full panel on right, narrow connecting panel on left. Links left to 18"D or 24"D work surface. Includes grommet.

\* Will not accommodate pedestal

CODE	PRICE	WIDTH (in/mm)	DEPTH (in/mm)	HEIGHT (in/mm)	VOLUME (ft3/m3)	WEIGHT (lbs/kg)
------	-------	---------------	---------------	----------------	-----------------	-----------------

24"D work surface	DSK-2424-BW-LL*	592	24/610	24/610	29/737	3/0.08	58/26
	DSK-2430-BW-LL*	623	30/762	24/610	29/737	3/0.08	63/29
	DSK-2436-BW-LL	658	36/914	24/610	29/737	3/0.08	72/33
	DSK-2442-BW-LL	698	42/1067	24/610	29/737	3/0.08	78/35
	DSK-2448-BW-LL	722	48/1219	24/610	29/737	4/0.11	86/39
	DSK-2454-BW-LL	755	54/1372	24/610	29/737	4/0.11	93/42
	DSK-2460-BW-LL	786	60/1524	24/610	29/737	5/0.14	100/45
30"D work surface	DSK-2466-BW-LL	820	66/1676	24/610	29/737	5/0.14	108/49
	DSK-2472-BW-LL	851	72/1829	24/610	29/737	5/0.14	116/53
	DSK-3030-BW-LL*	706	30/762	30/762	29/737	3/0.08	76/34
	DSK-3036-BW-LL	739	36/914	30/762	29/737	3/0.08	82/37
	DSK-3042-BW-LL	772	42/1067	30/762	29/737	3/0.08	91/41
	DSK-3048-BW-LL	804	48/1219	30/762	29/737	4/0.11	100/45
	DSK-3054-BW-LL	836	54/1372	30/762	29/737	4/0.11	108/49
DSK-3060-BW-LL	869	60/1524	30/762	29/737	5/0.14	116/53	
DSK-3066-BW-LL	900	66/1676	30/762	29/737	5/0.14	124/56	
DSK-3072-BW-LL	934	72/1829	30/762	29/737	5/0.14	132/60	

For optional 3/4 modesty panel (18in / 455mm high) add the suffix SM to the product code. i.e. DSK-2424-BW-LL-SM

For optional 1/4 modesty panel (10in / 254mm high) add the suffix MM to the product code. i.e. DSK-2424-BW-LL-MM

**Bowed Right Links-Right (DSK) - BW-LR**



Bowed desk with full panel on left, narrow connecting panel on right. Links right to 18"D or 24"D work surface. Includes grommet.

\* Will not accommodate pedestal

24"D work surface	DSK-2424-BW-LR*	592	24/610	24/610	29/737	3/0.08	58/26
	DSK-2430-BW-LR*	623	30/762	24/610	29/737	3/0.08	63/29
	DSK-2436-BW-LR	658	36/914	24/610	29/737	3/0.08	72/33
	DSK-2442-BW-LR	698	42/1067	24/610	29/737	3/0.08	78/35
	DSK-2448-BW-LR	722	48/1219	24/610	29/737	4/0.11	86/39
	DSK-2454-BW-LR	755	54/1372	24/610	29/737	4/0.11	93/42
	DSK-2460-BW-LR	786	60/1524	24/610	29/737	5/0.14	100/45
30"D work surface	DSK-2466-BW-LR	820	66/1676	24/610	29/737	5/0.14	108/49
	DSK-2472-BW-LR	851	72/1829	24/610	29/737	5/0.14	116/53
	DSK-3030-BW-LR*	706	30/762	30/762	29/737	3/0.08	76/34
	DSK-3036-BW-LR	739	36/914	30/762	29/737	3/0.08	82/37
	DSK-3042-BW-LR	772	42/1067	30/762	29/737	3/0.08	91/41
	DSK-3048-BW-LR	804	48/1219	30/762	29/737	4/0.11	100/45
	DSK-3054-BW-LR	836	54/1372	30/762	29/737	4/0.11	108/49
DSK-3060-BW-LR	869	60/1524	30/762	29/737	5/0.14	116/53	
DSK-3066-BW-LR	900	66/1676	30/762	29/737	5/0.14	124/56	
DSK-3072-BW-LR	934	72/1829	30/762	29/737	5/0.14	132/60	

For optional 3/4 modesty panel (18in / 455mm high) add the suffix SM to the product code. i.e. DSK-2424-BW-LR-SM

For optional 1/4 modesty panel (10in / 254mm high) add the suffix MM to the product code. i.e. DSK-2424-BW-LR-MM

For additional specification instructions see page 6. Desk components and extended gables can be found on page 123. Refer to pages 130-131 for electrical options and pages 132-133 for power/data, grommet placement options. See page 126 for keyboards and accessories. Divider panel sets and components available starting on page 102.



**Bowed Left Links-Center (DSK) - BW-LLC**

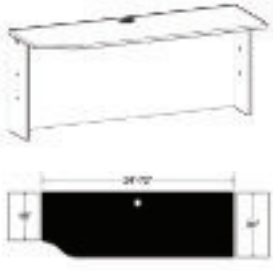

Bowed desk with connecting side panels. Links right to 24"D or 30"D work surface, left to 18"D or 24"D work surfaces. Includes grommet.

\* Will not accommodate pedestal

CODE	PRICE	WIDTH (in/mm)	DEPTH (in/mm)	HEIGHT (in/mm)	VOLUME (ft3/m3)	WEIGHT (lbs/kg)
------	-------	------------------	------------------	-------------------	--------------------	--------------------

24"D work surface	DSK-2424-BW-LLC*	592	24/610	24/610	29/737	3/0.08	51/23
	DSK-2430-BW-LLC*	623	30/762	24/610	29/737	3/0.08	56/25
	DSK-2436-BW-LLC	658	36/914	24/610	29/737	3/0.08	65/29
	DSK-2442-BW-LLC	698	42/1067	24/610	29/737	3/0.08	71/32
	DSK-2448-BW-LLC	722	48/1219	24/610	29/737	4/0.11	79/36
	DSK-2454-BW-LLC	755	54/1372	24/610	29/737	4/0.11	86/39
	DSK-2460-BW-LLC	786	60/1524	24/610	29/737	5/0.14	93/42
	DSK-2466-BW-LLC	820	66/1676	24/610	29/737	5/0.14	101/46
DSK-2472-BW-LLC	851	72/1829	24/610	29/737	5/0.14	109/49	
30"D work surface	DSK-3030-BW-LLC*	706	30/762	30/762	29/737	3/0.08	68/31
	DSK-3036-BW-LLC	739	36/914	30/762	29/737	3/0.08	74/34
	DSK-3042-BW-LLC	772	42/1067	30/762	29/737	3/0.08	83/38
	DSK-3048-BW-LLC	804	48/1219	30/762	29/737	4/0.11	92/42
	DSK-3054-BW-LLC	836	54/1372	30/762	29/737	4/0.11	100/45
	DSK-3060-BW-LLC	869	60/1524	30/762	29/737	5/0.14	108/49
	DSK-3066-BW-LLC	900	66/1676	30/762	29/737	5/0.14	116/53
	DSK-3072-BW-LLC	934	72/1829	30/762	29/737	5/0.14	124/56

For optional 3/4 modesty panel (18in / 455mm high) add the suffix SM to the product code. i.e. DSK-2424-BW-LLC-SM

For optional 1/4 modesty panel (10in / 254mm high) add the suffix MM to the product code. i.e. DSK-2424-BW-LLC-MM

**Bowed Right Links-Center (DSK) - BW-RLC**

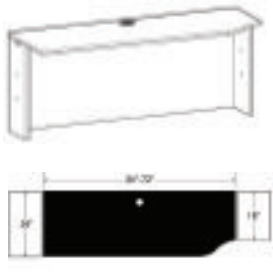

Bowed desk with two connecting panels. Links left to 24"D or 30"D work surface, right to 18"D or 24"D work surfaces. Includes grommet.

\* Will not accommodate pedestal

24"D work surface	DSK-2424-BW-RLC*	592	24/610	24/610	29/737	3/0.08	51/23
	DSK-2430-BW-RLC*	623	30/762	24/610	29/737	3/0.08	56/25
	DSK-2436-BW-RLC	658	36/914	24/610	29/737	3/0.08	65/29
	DSK-2442-BW-RLC	698	42/1067	24/610	29/737	3/0.08	71/32
	DSK-2448-BW-RLC	722	48/1219	24/610	29/737	4/0.11	79/36
	DSK-2454-BW-RLC	755	54/1372	24/610	29/737	4/0.11	86/39
	DSK-2460-BW-RLC	786	60/1524	24/610	29/737	5/0.14	93/42
	DSK-2466-BW-RLC	820	66/1676	24/610	29/737	5/0.14	101/46
DSK-2472-BW-RLC	851	72/1829	24/610	29/737	5/0.14	109/49	
30"D work surface	DSK-3030-BW-RLC*	706	30/762	30/762	29/737	3/0.08	68/31
	DSK-3036-BW-RLC	739	36/914	30/762	29/737	3/0.08	74/34
	DSK-3042-BW-RLC	772	42/1067	30/762	29/737	3/0.08	83/38
	DSK-3048-BW-RLC	804	48/1219	30/762	29/737	4/0.11	92/42
	DSK-3054-BW-RLC	836	54/1372	30/762	29/737	4/0.11	100/45
	DSK-3060-BW-RLC	869	60/1524	30/762	29/737	5/0.14	108/49
	DSK-3066-BW-RLC	900	66/1676	30/762	29/737	5/0.14	116/53
	DSK-3072-BW-RLC	934	72/1829	30/762	29/737	5/0.14	124/56

For optional 3/4 modesty panel (18in / 455mm high) add the suffix SM to the product code. i.e. DSK-2424-BW-RLC-SM

For optional 1/4 modesty panel (10in / 254mm high) add the suffix MM to the product code. i.e. DSK-2424-BW-RLC-MM

For additional specification instructions see page 6. Desk components and extended gables can be found on page 123. Refer to pages 130-131 for electrical options and pages 132-133 for power/data, grommet placement options. See page 126 for keyboards and accessories. Divider panel sets and components available starting on page 102.

**Bowed Links Center (DSK) - BW-LC**



Bowed desk with two connecting side panels. Links right and left to connecting 18"D or 24"D work surfaces. Includes grommet.



CODE	PRICE	WIDTH (in/mm)	DEPTH (in/mm)	HEIGHT (in/mm)	VOLUME (ft <sup>3</sup> /m <sup>3</sup> )	WEIGHT (lbs/kg)
------	-------	------------------	------------------	-------------------	--	--------------------

24"D work surface	DSK-2442-BW-LC	698	42/1067	24/610	29/737	3/0.08	71/32
	DSK-2448-BW-LC	722	48/1219	24/610	29/737	4/0.11	79/36
	DSK-2454-BW-LC	755	54/1372	24/610	29/737	4/0.11	86/39
	DSK-2460-BW-LC	786	60/1524	24/610	29/737	5/0.14	93/42
	DSK-2466-BW-LC	820	66/1676	24/610	29/737	5/0.14	101/46
	DSK-2472-BW-LC	851	72/1829	24/610	29/737	5/0.14	109/49
30"D work surface	DSK-3042-BW-LC	772	42/1067	30/762	29/737	3/0.08	83/38
	DSK-3048-BW-LC	804	48/1219	30/762	29/737	4/0.11	92/42
	DSK-3054-BW-LC	836	54/1372	30/762	29/737	4/0.11	100/45
	DSK-3060-BW-LC	869	60/1524	30/762	29/737	5/0.14	108/49
	DSK-3066-BW-LC	900	66/1676	30/762	29/737	5/0.14	116/53
	DSK-3072-BW-LC	934	72/1829	30/762	29/737	5/0.14	124/56

For optional 3/4 modesty panel (18in / 455mm high) add the suffix SM to the product code. i.e. DSK-2442-BW-LC-SM

For optional 1/4 modesty panel (10in / 254mm high) add the suffix MM to the product code. i.e. DSK-2442-BW-LC-MM

For additional specification instructions see page 6. Desk components and extended gables can be found on page 123. Refer to pages 130-131 for electrical options and pages 132-133 for power/data, grommet placement options. See page 126 for keyboards and accessories. Divider panel sets and components available starting on page 102.

**Bow Front Desk**



Bow front desk with full side panels, recessed back panel. No grommet.



Bow front desk with inset modesty. No grommet.

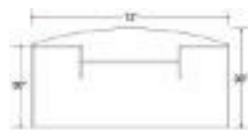

Bow front desk with inset glazed modesty. No grommet.

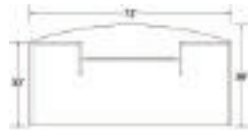

**Recessed Back Panel**



Desk with 30"D or 36"D work surface, two full side panels, recessed back panel. No grommet.



Executive desk with inset modesty. No grommet.

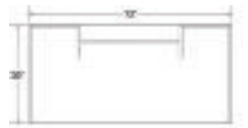

Executive desk with inset glazed modesty. No grommet.



CODE	PRICE	WIDTH (in/mm)	DEPTH (in/mm)	HEIGHT (in/mm)	VOLUME (ft <sup>3</sup> /m <sup>3</sup> )	WEIGHT (lbs/kg)
------	-------	------------------	------------------	-------------------	--	--------------------

DSK-3060-LBFTD	910	60/1524	36/914	29/737	5/0.14	110/50
DSK-3066-LBFTD	959	66/1676	36/914	29/737	5/0.14	130/59
DSK-3072-LBFTD	1008	72/1829	36/914	29/737	6/0.17	150/68

For optional 3/4 modesty panel (18in / 455mm high) add the suffix SM to the product code. i.e. DSK-3072-LBFTD-SM  
For optional 1/4 modesty panel (10in / 254mm high) add the suffix MM to the product code. i.e. DSK-3072-LBFTD-MM

DSK-3072-LBFTD-MLM	1568	72/1829	36/914	29/737	8/0.23	170/77
--------------------	------	---------	--------	--------	--------	--------

DSK-3072-LBFTD-M <sup>Z</sup>	1644	72/1829	36/914	29/737	8/0.23	170/77
-------------------------------	------	---------	--------	--------	--------	--------

M<sup>Z</sup> - Specify modesty frame colour

MSZ = Silver frame

MBZ = Black frame

MWZ = White frame

DSK-3060-LF-REC	772	60/1524	30/762	29/737	5/0.14	124/56
DSK-3066-LF-REC	836	66/1676	30/762	29/737	5/0.14	132/60
DSK-3072-LF-REC	851	72/1829	30/762	29/737	5/0.14	140/64
DSK-3672-LF-REC	1109	72/1829	36/914	29/737	6/0.17	150/68

For optional 3/4 modesty panel (18in / 455mm high) add the suffix SM to the product code. i.e. DSK-3072-LF-REC-SM  
For optional 1/4 modesty panel (10in / 254mm high) add the suffix MM to the product code. i.e. DSK-3072-LF-REC-MM

DSK-3672-LF-REC-MLM	1670	72/1829	36/914	29/737	8/0.23	170/77
---------------------	------	---------	--------	--------	--------	--------

DSK-3672-LF-REC-M <sup>Z</sup>	1742	72/1829	36/914	29/737	8/0.23	170/77
--------------------------------	------	---------	--------	--------	--------	--------

M<sup>Z</sup> - Specify modesty frame colour

MSZ = Silver frame

MBZ = Black frame

MWZ = White frame

For additional specification instructions see page 6. Desk components can be found on page 123.  
Refer to pages 130-131 for electrical options and pages 132-133 for power/data, grommet placement options.  
See page 126 for keyboards and accessories.

Links "DTI" Table - LC (Links Center)

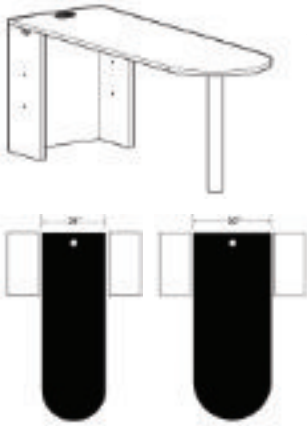

Free standing "D" shaped island work surface with narrow connecting side panels that link both left and right to connecting 24"D or 30"D work surfaces. Wire grommet included.

CODE	PRICE	WIDTH (in/mm)	DEPTH (in/mm)	HEIGHT (in/mm)	VOLUME (ft3/m3)	WEIGHT (lbs/kg)
------	-------	---------------	---------------	----------------	-----------------	-----------------

24"D	DTI-2436-LC	764	36/914	24/610	29/737	3/0.08	60/27
	DTI-2442-LC	780	42/1067	24/610	29/737	3/0.08	63/29
	DTI-2448-LC	797	48/1219	24/610	29/737	4/0.11	66/30
	DTI-2454-LC	811	54/1372	24/610	29/737	4/0.11	71/32
	DTI-2460-LC	828	60/1524	24/610	29/737	5/0.14	75/34
	DTI-2466-LC	862	66/1676	24/610	29/737	5/0.14	80/36
	DTI-2472-LC	893	72/1829	24/610	29/737	5/0.14	85/39
30"D	DTI-3036-LC	797	36/914	30/762	29/737	3/0.08	71/32
	DTI-3042-LC	811	42/1067	30/762	29/737	3/0.08	73/33
	DTI-3048-LC	828	48/1219	30/762	29/737	4/0.11	76/34
	DTI-3054-LC	846	54/1372	30/762	29/737	4/0.11	84/38
	DTI-3060-LC	862	60/1524	30/762	29/737	5/0.14	86/39
	DTI-3066-LC	893	66/1676	30/762	29/737	5/0.14	91/41
	DTI-3072-LC	926	72/1829	30/762	29/737	5/0.14	96/44
C2	148	Opt. black double post leg - add C2 to end of code					
C3	0	Opt. silver single post leg - add C3 to end of code					
C4	148	Opt. silver double post leg - add C4 to end of code					
FP	65	Opt. full modesty panel - add FP to end of code					

Links "DTI" Table - LI (Links Interchangeable)

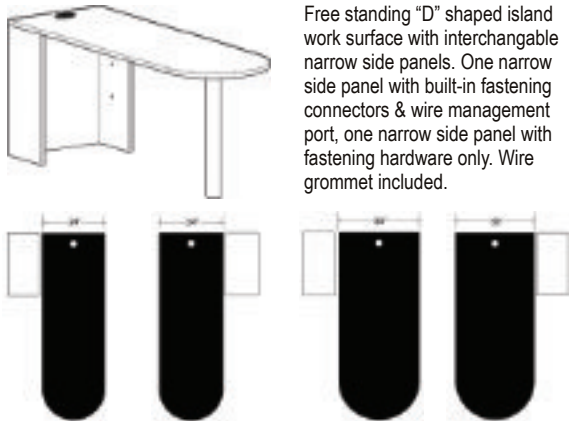

Free standing "D" shaped island work surface with interchangeable narrow side panels. One narrow side panel with built-in fastening connectors & wire management port, one narrow side panel with fastening hardware only. Wire grommet included.

24"D	DTI-2436-LI	764	36/914	24/610	29/737	3/0.08	60/27
	DTI-2442-LI	780	42/1067	24/610	29/737	3/0.08	63/29
	DTI-2448-LI	797	48/1219	24/610	29/737	4/0.11	66/30
	DTI-2454-LI	811	54/1372	24/610	29/737	4/0.11	71/32
	DTI-2460-LI	828	60/1524	24/610	29/737	5/0.14	75/34
	DTI-2466-LI	862	66/1676	24/610	29/737	5/0.14	80/36
	DTI-2472-LI	893	72/1829	24/610	29/737	5/0.14	85/39
30"D	DTI-3036-LI	797	36/914	30/762	29/737	3/0.08	71/32
	DTI-3042-LI	811	42/1067	30/762	29/737	3/0.08	73/33
	DTI-3048-LI	828	48/1219	30/762	29/737	4/0.11	76/34
	DTI-3054-LI	846	54/1372	30/762	29/737	4/0.11	84/38
	DTI-3060-LI	862	60/1524	30/762	29/737	5/0.14	86/39
	DTI-3066-LI	893	66/1676	30/762	29/737	5/0.14	91/41
	DTI-3072-LI	926	72/1829	30/762	29/737	5/0.14	96/44
C2	148	Opt. black double post leg - add C2 to end of code					
C3	0	Opt. silver single post leg - add C3 to end of code					
C4	148	Opt. silver double post leg - add C4 to end of code					
FP	65	Opt. full modesty panel - add FP to end of code					



Corner book shelf installed under "D" top.

BKC-2412-DICBH	566	24/610	12/305	28/711	5/0.14	30/14
BKC-3015-DICBH	584	30/762	15/381	28/711	7/0.20	35/16

For additional specification instructions see page 6. Desk components can be found on page 123. Refer to pages 130-131 for electrical options and pages 132-133 for power/data, grommet placement options.



Links "DTI" Table - NP (Narrow Panel)

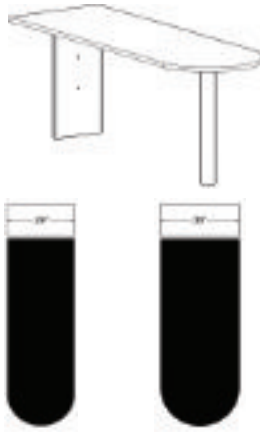

"D" shaped island work surface. Links at flush height to a 24" or 30" work surface. The addition of one narrow side panel allows an optional link to the adjoining side panel.

CODE	PRICE	WIDTH (in/mm)	DEPTH (in/mm)	HEIGHT (in/mm)	VOLUME (ft3/m3)	WEIGHT (lbs/kg)
------	-------	------------------	------------------	-------------------	--------------------	--------------------

24"D	DTI-2436-NP	601	36/914	24/610	29/737	2/0.06	32/15
	DTI-2442-NP	618	42/1067	24/610	29/737	2/0.06	37/17
	DTI-2448-NP	635	48/1219	24/610	29/737	2/0.06	41/19
	DTI-2454-NP	650	54/1372	24/610	29/737	3/0.08	46/21
	DTI-2460-NP	666	60/1524	24/610	29/737	3/0.08	50/23
	DTI-2466-NP	698	66/1676	24/610	29/737	3/0.08	59/27
	DTI-2472-NP	732	72/1829	24/610	29/737	3/0.08	68/31
30"D	DTI-3036-NP	635	36/914	30/762	29/737	2/0.06	36/16
	DTI-3042-NP	650	42/1067	30/762	29/737	2/0.06	41/19
	DTI-3048-NP	666	48/1219	30/762	29/737	2/0.06	46/21
	DTI-3054-NP	683	54/1372	30/762	29/737	3/0.08	51/23
	DTI-3060-NP	698	60/1524	30/762	29/737	3/0.08	56/25
	DTI-3066-NP	732	66/1676	30/762	29/737	3/0.08	66/30
	DTI-3072-NP	764	72/1829	30/762	29/737	3/0.08	76/34

C2	148	Opt. black double post leg - add C2 to end of code
C3	0	Opt. silver single post leg - add C3 to end of code
C4	148	Opt. silver double post leg - add C4 to end of code

Links "DTI" Table

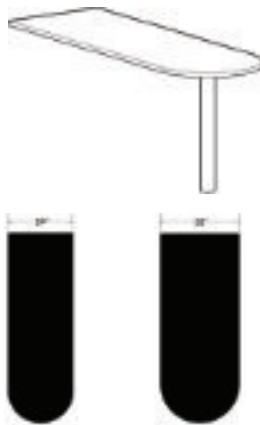

"D" shaped island work surface. Links at flush height to a 24" or 30" work surface.

24"D	DTI-2436	569	36/914	24/610	29/737	2/0.06	32/15
	DTI-2442	586	42/1067	24/610	29/737	2/0.06	37/17
	DTI-2448	601	48/1219	24/610	29/737	2/0.06	41/19
	DTI-2454	618	54/1372	24/610	29/737	3/0.08	46/21
	DTI-2460	635	60/1524	24/610	29/737	3/0.08	50/23
	DTI-2466	666	66/1676	24/610	29/737	3/0.08	59/27
	DTI-2472	698	72/1829	24/610	29/737	3/0.08	68/31
30"D	DTI-3036	601	36/914	30/762	29/737	2/0.06	36/16
	DTI-3042	618	42/1067	30/762	29/737	2/0.06	41/19
	DTI-3048	635	48/1219	30/762	29/737	2/0.06	46/21
	DTI-3054	650	54/1372	30/762	29/737	3/0.08	51/23
	DTI-3060	666	60/1524	30/762	29/737	3/0.08	56/25
	DTI-3066	698	66/1676	30/762	29/737	3/0.08	66/30
	DTI-3072	732	72/1829	30/762	29/737	3/0.08	76/34

C2	148	Opt. black double post leg - add C2 to end of code
C3	0	Opt. silver single post leg - add C3 to end of code
C4	148	Opt. silver double post leg - add C4 to end of code



Corner book shelf installed under "D" top.

BKC-2412-DICBH	566	24/610	12/305	28/711	5/0.14	30/14
BKC-3015-DICBH	584	30/762	15/381	28/711	7/0.20	35/16

For additional specification instructions see page 6. Desk components can be found on page 123. Refer to pages 130-131 for electrical options and pages 132-133 for power/data, grommet placement options.

Links "STI" Table - LC (Links Center)

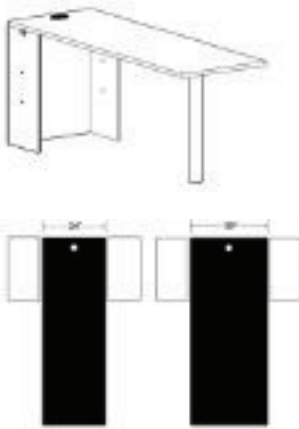

Free standing "S" shaped island work surface with narrow connecting side panels that link both left and right to connecting 24"D or 30"D work surfaces. Wire grommet included.

CODE	PRICE	WIDTH (in/mm)	DEPTH (in/mm)	HEIGHT (in/mm)	VOLUME (ft3/m3)	WEIGHT (lbs/kg)
24"D	STI-2436-LC	764	36/914	24/610	29/737	3/0.08 60/27
	STI-2442-LC	780	42/1067	24/610	29/737	3/0.08 63/29
	STI-2448-LC	797	48/1219	24/610	29/737	4/0.11 66/30
	STI-2454-LC	811	54/1372	24/610	29/737	4/0.11 71/32
	STI-2460-LC	828	60/1524	24/610	29/737	5/0.14 75/34
	STI-2466-LC	862	66/1676	24/610	29/737	5/0.14 80/36
	STI-2472-LC	893	72/1829	24/610	29/737	5/0.14 85/39
30"D	STI-3036-LC	797	36/914	30/762	29/737	3/0.08 71/32
	STI-3042-LC	811	42/1067	30/762	29/737	3/0.08 73/33
	STI-3048-LC	828	48/1219	30/762	29/737	4/0.11 76/34
	STI-3054-LC	846	54/1372	30/762	29/737	4/0.11 84/38
	STI-3060-LC	862	60/1524	30/762	29/737	5/0.14 86/39
	STI-3066-LC	893	66/1676	30/762	29/737	5/0.14 91/41
	STI-3072-LC	926	72/1829	30/762	29/737	5/0.14 96/44
C2	148	Opt. black double post leg - add C2 to end of code				
C3	0	Opt. silver single post leg - add C3 to end of code				
C4	148	Opt. silver double post leg - add C4 to end of code				
FP	65	Opt. full modesty panel - add FP to end of code				

Links "STI" Table - LI (Links Interchangeable)

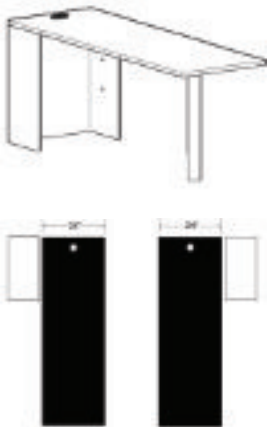

Free standing "S" shaped island work surface with interchangeable narrow side panels. One narrow side panel with built-in fastening connectors & wire management port, one narrow side panel with fastening hardware only. Wire grommet included.

24"D	STI-2436-LI	764	36/914	24/610	29/737	3/0.08 60/27
	STI-2442-LI	780	42/1067	24/610	29/737	3/0.08 63/29
	STI-2448-LI	797	48/1219	24/610	29/737	4/0.11 66/30
	STI-2454-LI	811	54/1372	24/610	29/737	4/0.11 71/32
	STI-2460-LI	828	60/1524	24/610	29/737	5/0.14 75/34
	STI-2466-LI	862	66/1676	24/610	29/737	5/0.14 80/36
	STI-2472-LI	893	72/1829	24/610	29/737	5/0.14 85/39
30"D	STI-3036-LI	797	36/914	30/762	29/737	3/0.08 71/32
	STI-3042-LI	811	42/1067	30/762	29/737	3/0.08 73/33
	STI-3048-LI	828	48/1219	30/762	29/737	4/0.11 76/34
	STI-3054-LI	846	54/1372	30/762	29/737	4/0.11 84/38
	STI-3060-LI	862	60/1524	30/762	29/737	5/0.14 86/39
	STI-3066-LI	893	66/1676	30/762	29/737	5/0.14 91/41
	STI-3072-LI	926	72/1829	30/762	29/737	5/0.14 96/44
C2	148	Opt. black double post leg - add C2 to end of code				
C3	0	Opt. silver single post leg - add C3 to end of code				
C4	148	Opt. silver double post leg - add C4 to end of code				
FP	65	Opt. full modesty panel - add FP to end of code				



Corner book shelf installed under "S" top.

BKC-2412-SISBH	566	24/610	12/305	28/711	5/0.14	30/14
BKC-3015-SISBH	584	30/762	15/381	28/711	7/0.20	35/16

For additional specification instructions see page 6. Desk components can be found on page 123. Refer to pages 130-131 for electrical options and pages 132-133 for power/data, grommet placement options.

Links "STI" Table - NP (Narrow Panel)

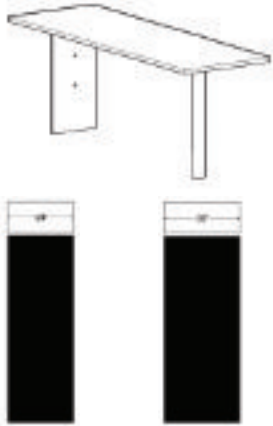

"S" shaped island work surface. Links at flush height to a 24" or 30" work surface. The addition of one narrow side panel allows an optional link to the adjoining side panel.

CODE	PRICE	WIDTH (in/mm)	DEPTH (in/mm)	HEIGHT (in/mm)	VOLUME (ft3/m3)	WEIGHT (lbs/kg)
------	-------	------------------	------------------	-------------------	--------------------	--------------------

24"D	STI-2436-NP	601	36/914	24/610	29/737	2/0.06	32/15
	STI-2442-NP	618	42/1067	24/610	29/737	2/0.06	37/17
	STI-2448-NP	635	48/1219	24/610	29/737	2/0.06	41/19
	STI-2454-NP	650	54/1372	24/610	29/737	3/0.08	46/21
	STI-2460-NP	666	60/1524	24/610	29/737	3/0.08	50/23
	STI-2466-NP	698	66/1676	24/610	29/737	3/0.08	59/27
	STI-2472-NP	732	72/1829	24/610	29/737	3/0.08	68/31
30"D	STI-3036-NP	635	36/914	30/762	29/737	2/0.06	36/16
	STI-3042-NP	650	42/1067	30/762	29/737	2/0.06	41/19
	STI-3048-NP	666	48/1219	30/762	29/737	2/0.06	46/21
	STI-3054-NP	683	54/1372	30/762	29/737	3/0.08	51/23
	STI-3060-NP	698	60/1524	30/762	29/737	3/0.08	56/25
	STI-3066-NP	732	66/1676	30/762	29/737	3/0.08	66/30
	STI-3072-NP	764	72/1829	30/762	29/737	3/0.08	76/34

- C2 148 Opt. black double post leg - add C2 to end of code
- C3 0 Opt. silver single post leg - add C3 to end of code
- C4 148 Opt. silver double post leg - add C4 to end of code

Links "STI" Table

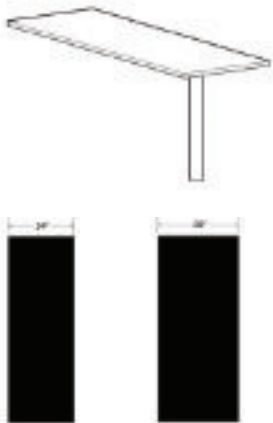

"S" shaped island work surface. Links at flush height to a 24" or 30" work surface.

24"D	STI-2436	569	36/914	24/610	29/737	2/0.06	32/15
	STI-2442	586	42/1067	24/610	29/737	2/0.06	37/17
	STI-2448	601	48/1219	24/610	29/737	2/0.06	41/19
	STI-2454	618	54/1372	24/610	29/737	3/0.08	46/21
	STI-2460	635	60/1524	24/610	29/737	3/0.08	50/23
	STI-2466	666	66/1676	24/610	29/737	3/0.08	59/27
	STI-2472	698	72/1829	24/610	29/737	3/0.08	68/31
30"D	STI-3036	601	36/914	30/762	29/737	2/0.06	36/16
	STI-3042	618	42/1067	30/762	29/737	2/0.06	41/19
	STI-3048	635	48/1219	30/762	29/737	2/0.06	46/21
	STI-3054	650	54/1372	30/762	29/737	3/0.08	51/23
	STI-3060	666	60/1524	30/762	29/737	3/0.08	56/25
	STI-3066	698	66/1676	30/762	29/737	3/0.08	66/30
	STI-3072	732	72/1829	30/762	29/737	3/0.08	76/34

- C2 148 Opt. black double post leg - add C2 to end of code
- C3 0 Opt. silver single post leg - add C3 to end of code
- C4 148 Opt. silver double post leg - add C4 to end of code



Corner book shelf installed under "S" top.

BKC-2412-SISBH	566	24/610	12/305	28/711	5/0.14	30/14
BKC-3015-SISBH	584	30/762	15/381	28/711	7/0.20	35/16

For additional specification instructions see page 6. Desk components can be found on page 123. Refer to pages 130-131 for electrical options and pages 132-133 for power/data, grommet placement options.

Links "PTI" Table - LC (Links Center)



Free standing "P" shaped island work surface with narrow connecting side panels that link both left and right to connecting 24"D or 30"D work surfaces. Wire grommet included.

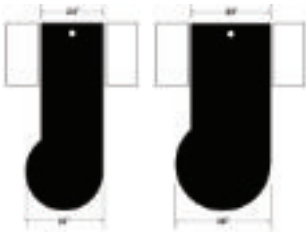

CODE	PRICE	WIDTH (in/mm)	DEPTH (in/mm)	HEIGHT (in/mm)	VOLUME (ft3/m3)	WEIGHT (lbs/kg)
------	-------	---------------	---------------	----------------	-----------------	-----------------

24"D	PTI-2460-LC	973	60/1524	30/762	29/737	4/0.11 79/36
	PTI-2466-LC	1008	66/1676	30/762	29/737	4/0.11 83/38
	PTI-2472-LC	1039	72/1829	30/762	29/737	5/0.14 88/40
30"D	PTI-3060-LC	1072	60/1524	36/914	29/737	5/0.14 93/42
	PTI-3066-LC	1104	66/1676	36/914	29/737	5/0.14 98/44
	PTI-3072-LC	1138	72/1829	36/914	29/737	6/0.17 103/47

C2	148	Opt. black double post leg - add C2 to end of code
C3	0	Opt. silver single post leg - add C3 to end of code
C4	148	Opt. silver double post leg - add C4 to end of code
FP	65	Opt. full modesty panel - add FP to end of code

Links "PTI" Table - LI (Links Interchangeable)



Free standing "P" shaped island work surface with interchangeable narrow side panels. One narrow panel with built-in fastening connectors & wire management port, one narrow panel with fastening hardware only. Grommet included.

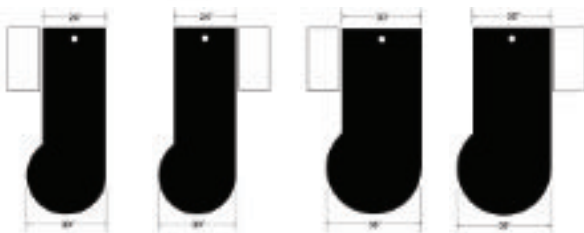

24"D	PTI-2460-LI	973	60/1524	30/762	29/737	4/0.11 79/36
	PTI-2466-LI	1008	66/1676	30/762	29/737	4/0.11 83/38
	PTI-2472-LI	1039	72/1829	30/762	29/737	5/0.14 88/40
30"D	PTI-3060-LI	1072	60/1524	36/914	29/737	5/0.14 93/42
	PTI-3066-LI	1104	66/1676	36/914	29/737	5/0.14 98/44
	PTI-3072-LI	1138	72/1829	36/914	29/737	6/0.17 103/47

C2	148	Opt. black double post leg - add C2 to end of code
C3	0	Opt. silver single post leg - add C3 to end of code
C4	148	Opt. silver double post leg - add C4 to end of code
FP	65	Opt. full modesty panel - add FP to end of code

For additional specification instructions see page 6. Desk components can be found on page 123. Refer to pages 130-131 for electrical options and pages 132-133 for power/data, grommet placement options.

Links "PTI" Table - NP (Narrow Panel)

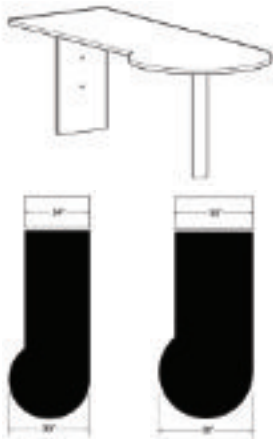

"P" shaped island work surface. Links at flush height to a 24" or 30" work surface. The addition of one narrow side panel allows an optional link to the adjoining side panel.

CODE	PRICE	WIDTH (in/mm)	DEPTH (in/mm)	HEIGHT (in/mm)	VOLUME (ft3/m3)	WEIGHT (lbs/kg)
24"D	PTI-2460-NP	910	60/1524	30/762	29/737	3/0.08 56/25
	PTI-2466-NP	941	66/1676	30/762	29/737	3/0.08 64/29
	PTI-2472-NP	973	72/1829	30/762	29/737	4/0.11 72/33
30"D	PTI-3060-NP	1008	60/1524	36/914	29/737	4/0.11 60/27
	PTI-3066-NP	1039	66/1676	36/914	29/737	4/0.11 67/30
	PTI-3072-NP	1072	72/1829	36/914	29/737	5/0.14 74/34
C2	148	Opt. black double post leg - add C2 to end of code				
C3	0	Opt. silver single post leg - add C3 to end of code				
C4	148	Opt. silver double post leg - add C4 to end of code				

Links "PTI" Table

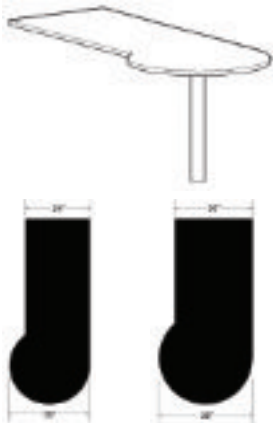

"P" shaped island work surface. Links at flush height to a 24" or 30" work surface.

24"D	PTI-2460	845	60/1524	30/762	29/737	3/0.08 56/25
	PTI-2466	876	66/1676	30/762	29/737	3/0.08 64/29
	PTI-2472	910	72/1829	30/762	29/737	4/0.11 72/33
30"D	PTI-3060	941	60/1524	36/914	29/737	4/0.11 60/27
	PTI-3066	973	66/1676	36/914	29/737	4/0.11 67/30
	PTI-3072	1008	72/1829	36/914	29/737	5/0.14 74/34
C2	148	Opt. black double post leg - add C2 to end of code				
C3	0	Opt. silver single post leg - add C3 to end of code				
C4	148	Opt. silver double post leg - add C4 to end of code				

For additional specification instructions see page 6. Desk components can be found on page 123. Refer to pages 130-131 for electrical options and pages 132-133 for power/data, grromet placement options.



**Links "QTI" Table - LC (Links Center)**



Free standing "Q" shaped island work surface with narrow connecting side panels that link both left and right to connecting 24"D or 30"D work surfaces. Wire grommet included.

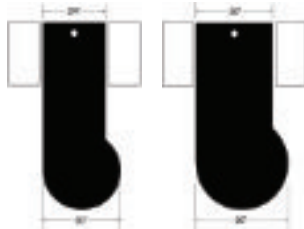

CODE	PRICE	WIDTH (in/mm)	DEPTH (in/mm)	HEIGHT (in/mm)	VOLUME (ft3/m3)	WEIGHT (lbs/kg)
------	-------	---------------	---------------	----------------	-----------------	-----------------

24"D	QTI-2460-LC	973	60/1524	30/762	29/737	4/0.11 79/36
	QTI-2466-LC	1008	66/1676	30/762	29/737	4/0.11 83/38
	QTI-2472-LC	1039	72/1829	30/762	29/737	5/0.14 88/40
30"D	QTI-3060-LC	1072	60/1524	36/914	29/737	5/0.14 93/42
	QTI-3066-LC	1104	66/1676	36/914	29/737	5/0.14 98/44
	QTI-3072-LC	1138	72/1829	36/914	29/737	6/0.17 103/47

C2	148	Opt. black double post leg - add C2 to end of code
C3	0	Opt. silver single post leg - add C3 to end of code
C4	148	Opt. silver double post leg - add C4 to end of code
FP	65	Opt. full modesty panel - add FP to end of code

**Links "QTI" Table - LI (Links Interchangeable)**



Free standing "Q" shaped island work surface with interchangeable narrow side panels. One narrow panel with built-in fastening connectors & wire management port, one narrow panel with fastening hardware only. Grommet included.

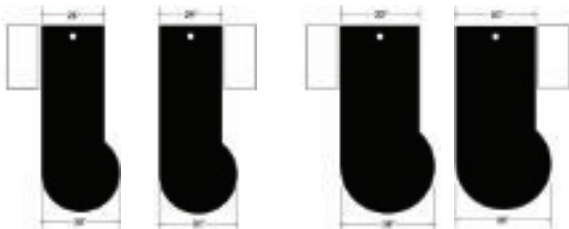

24"D	QTI-2460-LI	973	60/1524	30/762	29/737	4/0.11 79/36
	QTI-2466-LI	1008	66/1676	30/762	29/737	4/0.11 83/38
	QTI-2472-LI	1039	72/1829	30/762	29/737	5/0.14 88/40
30"D	QTI-3060-LI	1072	60/1524	36/914	29/737	5/0.14 93/42
	QTI-3066-LI	1104	66/1676	36/914	29/737	5/0.14 98/44
	QTI-3072-LI	1138	72/1829	36/914	29/737	6/0.17 103/47

C2	148	Opt. black double post leg - add C2 to end of code
C3	0	Opt. silver single post leg - add C3 to end of code
C4	148	Opt. silver double post leg - add C4 to end of code
FP	65	Opt. full modesty panel - add FP to end of code

For additional specification instructions see page 6. Desk components can be found on page 123. Refer to pages 130-131 for electrical options and pages 132-133 for power/data, grommet placement options.

Links "QTI" Table - NP (Narrow Panel)

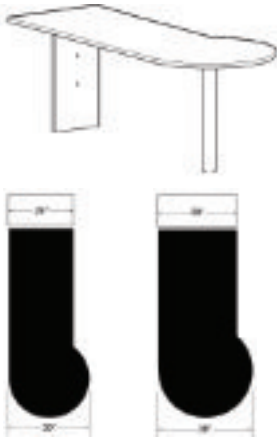

"Q" shaped island work surface. Links at flush height to a 24" or 30" work surface. The addition of one narrow side panel allows an optional link to the adjoining side panel.

CODE	PRICE	WIDTH (in/mm)	DEPTH (in/mm)	HEIGHT (in/mm)	VOLUME (ft3/m3)	WEIGHT (lbs/kg)
------	-------	---------------	---------------	----------------	-----------------	-----------------

24"D	QTI-2460-NP	910	60/1524	30/762	29/737	3/0.08	56/25
	QTI-2466-NP	941	66/1676	30/762	29/737	3/0.08	64/29
	QTI-2472-NP	973	72/1829	30/762	29/737	4/0.11	72/33
30"D	QTI-3060-NP	1008	60/1524	36/914	29/737	4/0.11	60/27
	QTI-3066-NP	1039	66/1676	36/914	29/737	4/0.11	67/30
	QTI-3072-NP	1072	72/1829	36/914	29/737	5/0.14	74/34
C2	148	Opt. black double post leg - add C2 to end of code					
C3	0	Opt. silver single post leg - add C3 to end of code					
C4	148	Opt. silver double post leg - add C4 to end of code					

Links "QTI" Table

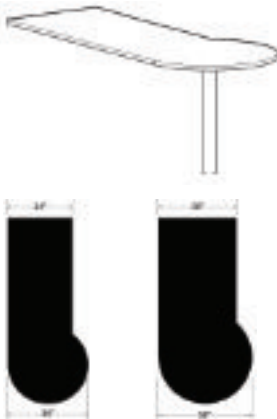

"Q" shaped island work surface. Links at flush height to a 24" or 30" work surface.

24"D	QTI-2460	845	60/1524	30/762	29/737	3/0.08	56/25
	QTI-2466	876	66/1676	30/762	29/737	3/0.08	64/29
	QTI-2472	910	72/1829	30/762	29/737	4/0.11	72/33
30"D	QTI-3060	941	60/1524	36/914	29/737	4/0.11	60/27
	QTI-3066	973	66/1676	36/914	29/737	4/0.11	67/30
	QTI-3072	1008	72/1829	36/914	29/737	5/0.14	74/34
C2	148	Opt. black double post leg - add C2 to end of code					
C3	0	Opt. silver single post leg - add C3 to end of code					
C4	148	Opt. silver double post leg - add C4 to end of code					

For additional specification instructions see page 6. Desk components can be found on page 123. Refer to pages 130-131 for electrical options and pages 132-133 for power/data, grommet placement options.

Links "LTI" Table - LL (Links Left)

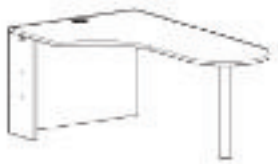

"L" shaped island work surface. Links left to connecting 24" work surface. Curved shape accommodates full keyboard. Wire grommet included.

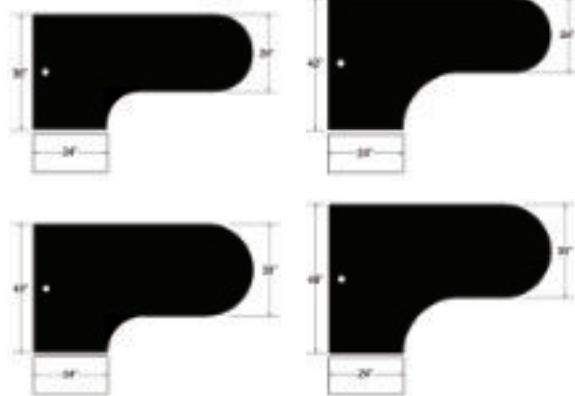

CODE	PRICE	WIDTH (in/mm)	DEPTH (in/mm)	HEIGHT (in/mm)	VOLUME (ft3/m3)	WEIGHT (lbs/kg)
------	-------	---------------	---------------	----------------	-----------------	-----------------

24"D	LTI-2466-36-LL	1186	66/1676	36/914	29/737	7/0.20	135/61
	LTI-2466-42-LL	1186	66/1676	42/1067	29/737	7/0.20	143/65
	LTI-2472-36-LL	1218	72/1829	36/914	29/737	8/0.23	141/64
	LTI-2472-42-LL	1218	72/1829	42/1067	29/737	8/0.23	149/68
30"D	LTI-3066-42-LL	1348	66/1676	42/1067	29/737	8/0.23	141/64
	LTI-3066-48-LL	1348	66/1676	48/1219	29/737	8/0.23	149/68
	LTI-3072-42-LL	1381	72/1829	42/1067	29/737	9/0.25	150/68
	LTI-3072-48-LL	1381	72/1829	48/1219	29/737	9/0.25	158/72

C2	148	Opt. black double post leg - add C2 to end of code
C3	0	Opt. silver single post leg - add C3 to end of code
C4	148	Opt. silver double post leg - add C4 to end of code
FP	65	Opt. full modesty panel - add FP to end of code

Links "LTI" Table - LR (Links Right)

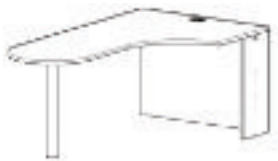

"L" shaped island work surface. Links right to connecting 24" work surface. Curved shape accommodates full keyboard. Wire grommet included.

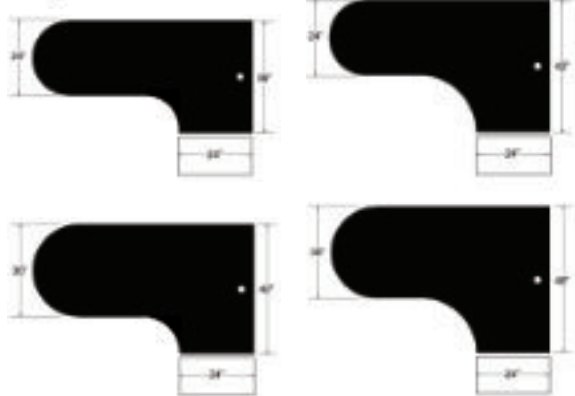

24"D	LTI-2466-36-LR	1186	66/1676	36/914	29/737	7/0.20	135/61
	LTI-2466-42-LR	1186	66/1676	42/1067	29/737	7/0.20	143/65
	LTI-2472-36-LR	1218	72/1829	36/914	29/737	8/0.23	141/64
	LTI-2472-42-LR	1218	72/1829	42/1067	29/737	8/0.23	149/68
30"D	LTI-3066-42-LR	1348	66/1676	42/1067	29/737	8/0.23	141/64
	LTI-3066-48-LR	1348	66/1676	48/1219	29/737	8/0.23	149/68
	LTI-3072-42-LR	1381	72/1829	42/1067	29/737	9/0.25	150/68
	LTI-3072-48-LR	1381	72/1829	48/1219	29/737	9/0.25	158/72

C2	148	Opt. black double post leg - add C2 to end of code
C3	0	Opt. silver single post leg - add C3 to end of code
C4	148	Opt. silver double post leg - add C4 to end of code
FP	65	Opt. full modesty panel - add FP to end of code

For additional specification instructions see page 6. Desk components can be found on page 123. Refer to pages 130-131 for electrical options and pages 132-133 for power/data, grommet placement options.

Links "LTI" Table - KLL (Links Left)



"L" shaped island work surface. Links left to connecting 24" work surface. Keyboard Edge. Wire grommet included.

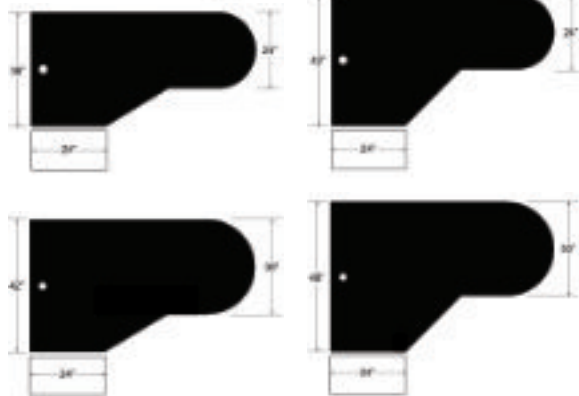

CODE	PRICE	WIDTH (in/mm)	DEPTH (in/mm)	HEIGHT (in/mm)	VOLUME (ft3/m3)	WEIGHT (lbs/kg)
------	-------	---------------	---------------	----------------	-----------------	-----------------

24"D	LTI-2466-36-KLL	1186	66/1676	36/914	29/737	7/0.20	135/61
	LTI-2466-42-KLL	1186	66/1676	42/1067	29/737	7/0.20	143/65
	LTI-2472-36-KLL	1218	72/1829	36/914	29/737	8/0.23	141/64
	LTI-2472-42-KLL	1218	72/1829	42/1067	29/737	8/0.23	149/68
30"D	LTI-3066-42-KLL	1348	66/1676	42/1067	29/737	8/0.23	141/64
	LTI-3066-48-KLL	1348	66/1676	48/1219	29/737	8/0.23	149/68
	LTI-3072-42-KLL	1381	72/1829	42/1067	29/737	9/0.25	150/68
	LTI-3072-48-KLL	1381	72/1829	48/1219	29/737	9/0.25	158/72

C2	148	Opt. black double post leg - add C2 to end of code
C3	0	Opt. silver single post leg - add C3 to end of code
C4	148	Opt. silver double post leg - add C4 to end of code
FP	65	Opt. full modesty panel - add FP to end of code

Links "LTI" Table - KLR (Links Right)

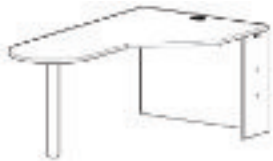

"L" shaped island work surface. Links right to connecting 24" work surface. Keyboard Edge. Wire grommet included.

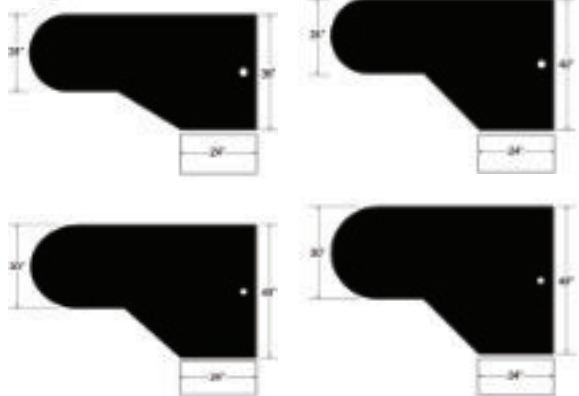

24"D	LTI-2466-36-KLR	1186	66/1676	36/914	29/737	7/0.20	135/61
	LTI-2466-42-KLR	1186	66/1676	42/1067	29/737	7/0.20	143/65
	LTI-2472-36-KLR	1218	72/1829	36/914	29/737	8/0.23	141/64
	LTI-2472-42-KLR	1218	72/1829	42/1067	29/737	8/0.23	149/68
30"D	LTI-3066-42-KLR	1348	66/1676	42/1067	29/737	8/0.23	141/64
	LTI-3066-48-KLR	1348	66/1676	48/1219	29/737	8/0.23	149/68
	LTI-3072-42-KLR	1381	72/1829	42/1067	29/737	9/0.25	150/68
	LTI-3072-48-KLR	1381	72/1829	48/1219	29/737	9/0.25	158/72

C2	148	Opt. black double post leg - add C2 to end of code
C3	0	Opt. silver single post leg - add C3 to end of code
C4	148	Opt. silver double post leg - add C4 to end of code
FP	65	Opt. full modesty panel - add FP to end of code

For additional specification instructions see page 6. Desk components can be found on page 123. Refer to pages 130-131 for electrical options and pages 132-133 for power/data, grommet placement options.

Links "FTI" Table - LL (Links Left)

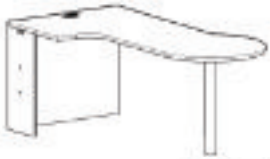

"F" shaped island work surface. Links left to connecting 24" work surface. Curved shape accommodates full keyboard. Wire grommet included.

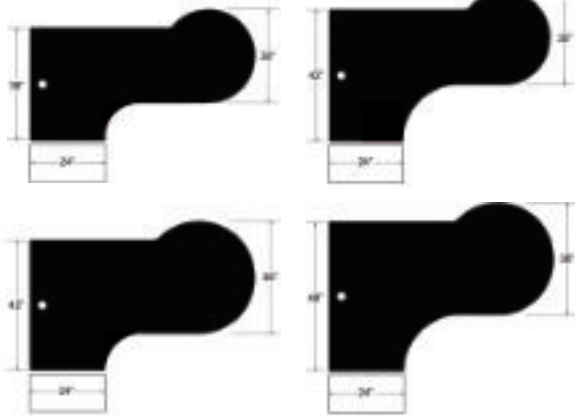

CODE	PRICE	WIDTH (in/mm)	DEPTH (in/mm)	HEIGHT (in/mm)	VOLUME (ft <sup>3</sup> /m <sup>3</sup> )	WEIGHT (lbs/kg)
------	-------	---------------	---------------	----------------	---	-----------------

24"D	FTI-2466-36-LL	1186	66/1676	42/1067	29/737	7/0.20	135/61
	FTI-2466-42-LL	1186	66/1676	48/1219	29/737	7/0.20	143/65
	FTI-2472-36-LL	1218	72/1829	42/1067	29/737	8/0.23	141/64
	FTI-2472-42-LL	1218	72/1829	48/1219	29/737	8/0.23	149/68
30"D	FTI-3066-42-LL	1348	66/1676	48/1219	29/737	8/0.23	141/64
	FTI-3066-48-LL	1348	66/1676	54/1372	29/737	8/0.23	149/68
	FTI-3072-42-LL	1381	72/1829	48/1219	29/737	9/0.25	150/68
	FTI-3072-48-LL	1381	72/1829	54/1372	29/737	9/0.25	158/72
C2	148	Opt. black double post leg - add C2 to end of code					
C3	0	Opt. silver single post leg - add C3 to end of code					
C4	148	Opt. silver double post leg - add C4 to end of code					
FP	65	Opt. full modesty panel - add FP to end of code					

Links "FTI" Table - LR (Links Right)

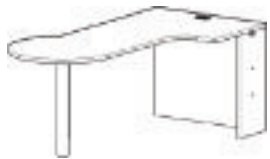

"F" shaped island work surface. Links right to connecting 24" work surface. Curved shape accommodates full keyboard. Wire grommet included.

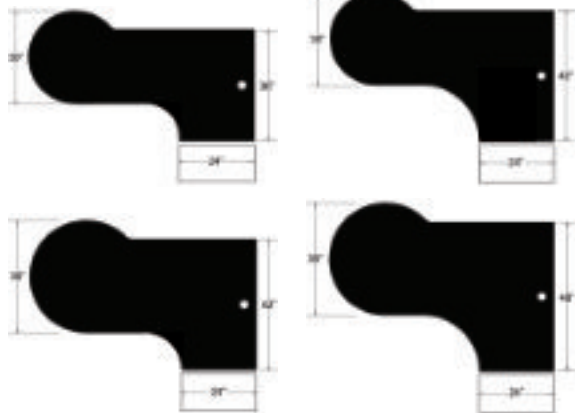

24"D	FTI-2466-36-LR	1186	66/1676	42/1067	29/737	7/0.20	135/61
	FTI-2466-42-LR	1186	66/1676	48/1219	29/737	7/0.20	143/65
	FTI-2472-36-LR	1218	72/1829	42/1067	29/737	8/0.23	141/64
	FTI-2472-42-LR	1218	72/1829	48/1219	29/737	8/0.23	149/68
30"D	FTI-3066-42-LR	1348	66/1676	48/1219	29/737	8/0.23	141/64
	FTI-3066-48-LR	1348	66/1676	54/1372	29/737	8/0.23	149/68
	FTI-3072-42-LR	1381	72/1829	48/1219	29/737	9/0.25	150/68
	FTI-3072-48-LR	1381	72/1829	54/1372	29/737	9/0.25	158/72
C2	148	Opt. black double post leg - add C2 to end of code					
C3	0	Opt. silver single post leg - add C3 to end of code					
C4	148	Opt. silver double post leg - add C4 to end of code					
FP	65	Opt. full modesty panel - add FP to end of code					

For additional specification instructions see page 6. Desk components can be found on page 123. Refer to pages 130-131 for electrical options and pages 132-133 for power/data, grommet placement options.

Links "FTI" Table - KLL (Links Left)

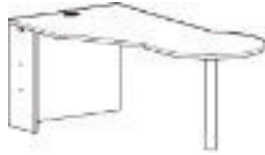

"F" shaped island work surface. Links left to connecting 24" work surface. Keyboard Edge. Wire grommet included.

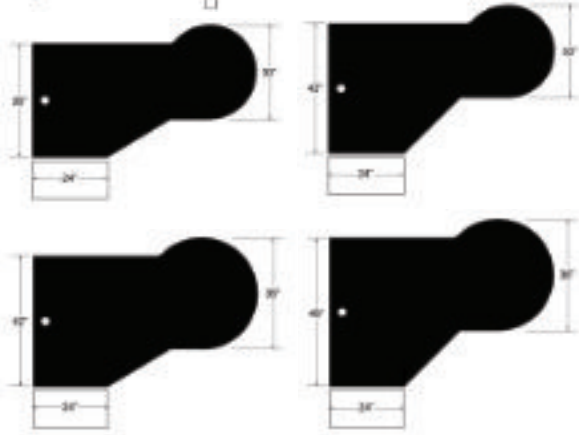

CODE	PRICE	WIDTH (in/mm)	DEPTH (in/mm)	HEIGHT (in/mm)	VOLUME (ft3/m3)	WEIGHT (lbs/kg)
------	-------	---------------	---------------	----------------	-----------------	-----------------

24"D	FTI-2466-36-KLL	1186	66/1676	42/1067	29/737	7/0.20	135/61
	FTI-2466-42-KLL	1186	66/1676	48/1219	29/737	7/0.20	143/65
	FTI-2472-36-KLL	1218	72/1829	42/1067	29/737	8/0.23	141/64
	FTI-2472-42-KLL	1218	72/1829	48/1219	29/737	8/0.23	149/68
30"D	FTI-3066-42-KLL	1348	66/1676	48/1219	29/737	8/0.23	141/64
	FTI-3066-48-KLL	1348	66/1676	54/1372	29/737	8/0.23	149/68
	FTI-3072-42-KLL	1381	72/1829	48/1219	29/737	9/0.25	150/68
	FTI-3072-48-KLL	1381	72/1829	54/1372	29/737	9/0.25	158/72

C2	148	Opt. black double post leg - add C2 to end of code
C3	0	Opt. silver single post leg - add C3 to end of code
C4	148	Opt. silver double post leg - add C4 to end of code
FP	65	Opt. full modesty panel - add FP to end of code

Links "FTI" Table - KLR (Links Right)



"F" shaped island work surface. Links right to connecting 24" work surface. Keyboard Edge. Wire grommet included.

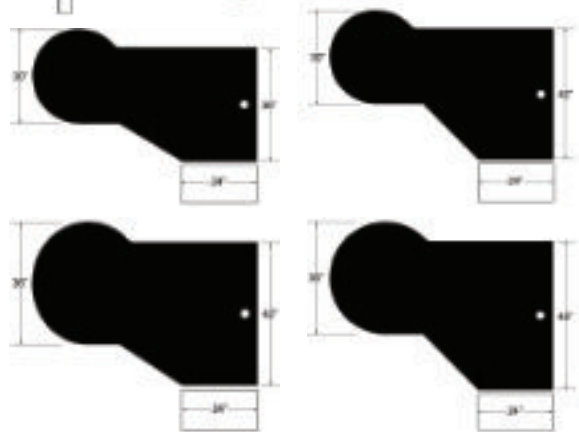

24"D	FTI-2466-36-KLR	1186	66/1676	42/1067	29/737	7/0.20	135/61
	FTI-2466-42-KLR	1186	66/1676	48/1219	29/737	7/0.20	143/65
	FTI-2472-36-KLR	1218	72/1829	42/1067	29/737	8/0.23	141/64
	FTI-2472-42-KLR	1218	72/1829	48/1219	29/737	8/0.23	149/68
30"D	FTI-3066-42-KLR	1348	66/1676	48/1219	29/737	8/0.23	141/64
	FTI-3066-48-KLR	1348	66/1676	54/1372	29/737	8/0.23	149/68
	FTI-3072-42-KLR	1381	72/1829	48/1219	29/737	9/0.25	150/68
	FTI-3072-48-KLR	1381	72/1829	54/1372	29/737	9/0.25	158/72

C2	148	Opt. black double post leg - add C2 to end of code
C3	0	Opt. silver single post leg - add C3 to end of code
C4	148	Opt. silver double post leg - add C4 to end of code
FP	65	Opt. full modesty panel - add FP to end of code

For additional specification instructions see page 6. Desk components can be found on page 123. Refer to pages 130-131 for electrical options and pages 132-133 for power/data, grommet placement options.



Links "JT1" Table



"J" shaped island work surface. Links left or right to connecting 24" work surface. Wire grommet included.

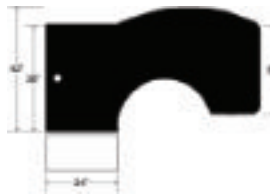

LL  
(Links Left)



LR  
(Links Right)

Links "GT1" Table

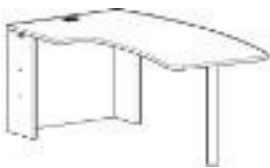

"G" shaped island work surface. Links left or right to connecting 24" work surface. Wire grommet included.



LL  
(Links Left)



LR  
(Links Right)

Links "RT1" Table



"R" shaped island work surface. Links left or right to connecting 20" work surface. Wire grommet included.



LL  
(Links Left)



LR  
(Links Right)

CODE	PRICE	WIDTH (in/mm)	DEPTH (in/mm)	HEIGHT (in/mm)	VOLUME (ft3/m3)	WEIGHT (lbs/kg)
------	-------	------------------	------------------	-------------------	--------------------	--------------------

JTI-3072-LL	1381	72/1829	42/1067	29/737	9/0.25	158/72
JTI-3072-LR	1381	72/1829	42/1067	29/737	9/0.25	158/72

C2	148	Opt. black double post leg - add C2 to end of code				
C3	0	Opt. silver single post leg - add C3 to end of code				
C4	148	Opt. silver double post leg - add C4 to end of code				
FP	65	Opt. full modesty panel - add FP to end of code				

GTI-3072-LL	1381	72/1829	42/1067	29/737	9/0.25	158/72
GTI-3072-LR	1381	72/1829	42/1067	29/737	9/0.25	158/72

C2	148	Opt. black double post leg - add C2 to end of code				
C3	0	Opt. silver single post leg - add C3 to end of code				
C4	148	Opt. silver double post leg - add C4 to end of code				
FP	65	Opt. full modesty panel - add FP to end of code				

RTI-3072-LL	1381	72/1829	36/914	29/737	8/0.23	150/68
RTI-3072-LR	1381	72/1829	36/914	29/737	8/0.23	150/68

C2	148	Opt. black double post leg - add C2 to end of code				
C3	0	Opt. silver single post leg - add C3 to end of code				
C4	148	Opt. silver double post leg - add C4 to end of code				
FP	65	Opt. full modesty panel - add FP to end of code				

For additional specification instructions see page 6. Desk components can be found on page 123. Refer to pages 130-131 for electrical options and pages 132-133 for power/data, grommet placement options.

Links "VTI" Table - LL (Links Left)

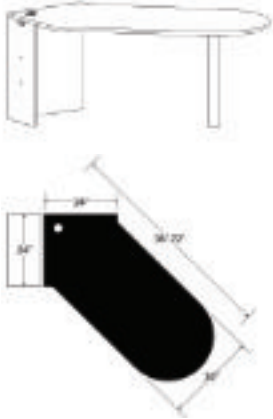

"V" shaped island work surface. Links left to connecting 24" work surface. Wire grommet included.

CODE	PRICE	WIDTH (in/mm)	DEPTH (in/mm)	HEIGHT (in/mm)	VOLUME (ft3/m3)	WEIGHT (lbs/kg)
------	-------	---------------	---------------	----------------	-----------------	-----------------

VTI-3036-LL	895	36/914	30/762	29/737	3.5/0.10	76/34
VTI-3042-LL	923	42/1067	30/762	29/737	4.0/0.11	81/37
VTI-3048-LL	949	48/1219	30/762	29/737	4.5/0.13	86/39
VTI-3054-LL	976	54/1372	30/762	29/737	5.0/0.14	91/41
VTI-3060-LL	1002	60/1524	30/762	29/737	5.5/0.16	96/44
VTI-3066-LL	1030	66/1676	30/762	29/737	6.0/0.17	101/46
VTI-3072-LL	1056	72/1829	30/762	29/737	6.5/0.18	106/48

C2	148	Opt. black double post leg - add C2 to end of code
C3	0	Opt. silver single post leg - add C3 to end of code
C4	148	Opt. silver double post leg - add C4 to end of code

Links "VTI" Table - LR (Links Right)

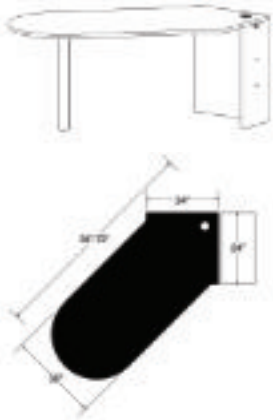

"V" shaped island work surface. Links right to connecting 24" work surface. Wire grommet included.

VTI-3036-LR	895	36/914	30/762	29/737	3.5/0.10	76/34
VTI-3042-LR	923	42/1067	30/762	29/737	4.0/0.11	81/37
VTI-3048-LR	949	48/1219	30/762	29/737	4.5/0.13	86/39
VTI-3054-LR	976	54/1372	30/762	29/737	5.0/0.14	91/41
VTI-3060-LR	1002	60/1524	30/762	29/737	5.5/0.16	96/44
VTI-3066-LR	1030	66/1676	30/762	29/737	6.0/0.17	101/46
VTI-3072-LR	1056	72/1829	30/762	29/737	6.5/0.18	106/48

C2	148	Opt. black double post leg - add C2 to end of code
C3	0	Opt. silver single post leg - add C3 to end of code
C4	148	Opt. silver double post leg - add C4 to end of code

For additional specification instructions see page 6. Desk components can be found on page 123. Refer to pages 130-131 for electrical options.



**Curved Corner Unit - (COR) Links Free - 18"**

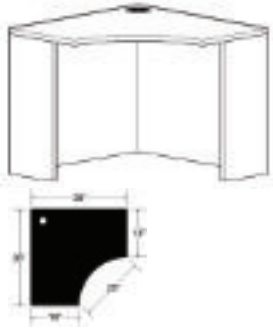

Links free, non-connecting corner unit, two narrow finished side panels. Curved shape accommodates full keyboard. Wire grommet included.

CODE	PRICE	WIDTH (in/mm)	DEPTH (in/mm)	HEIGHT (in/mm)	VOLUME (ft3/m3)	WEIGHT (lbs/kg)
COR-3618-CLF	772	36/914	36/914	29/737	5/0.14	92/42

For optional 3/4 modesty panel (18in / 455mm high) on right (default) add suffix SMR to product code. i.e. COR-3618-CLF-SMR or SML on the left i.e. COR-3618-CLF-SML

For optional 1/4 modesty panel (10in / 254mm high) on right (default) add suffix MMR to product code. i.e. COR-3618-CLF-MMR or SML on the left i.e. COR-3618-CLF-MML

**Curved Corner Unit - (COR) Links Left - 18"**



Corner unit with one narrow connecting side panel on left side and one finished side panel on right side. Links left to connecting 18" work surface. Curved shape accommodates full keyboard. Wire grommet included.

COR-3618-CLL	772	36/914	36/914	29/737	5/0.14	92/42
--------------	-----	--------	--------	--------	--------	-------

For optional 3/4 modesty panel (18in / 455mm high) on right (default) add suffix SMR to product code. i.e. COR-3618-CLL-SMR or SML on the left i.e. COR-3618-CLL-SML

For optional 1/4 modesty panel (10in / 254mm high) on right (default) add suffix MMR to product code. i.e. COR-3618-CLL-MMR or SML on the left i.e. COR-3618-CLL-MML

**Curved Corner Unit - (COR) Links Right - 18"**

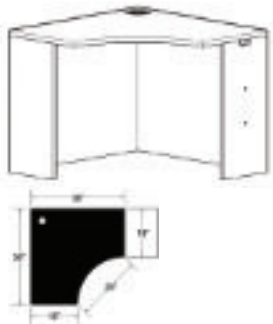

Corner unit with one narrow connecting side panel on right side and one finished side panel on left side. Links right to connecting 18" work surface. Curved shape accommodates full keyboard. Wire grommet included.

COR-3618-CLR	772	36/914	36/914	29/737	5/0.14	92/42
--------------	-----	--------	--------	--------	--------	-------

For optional 3/4 modesty panel (18in / 455mm high) on right (default) add suffix SMR to product code. i.e. COR-3618-CLR-SMR or SML on the left i.e. COR-3618-CLR-SML

For optional 1/4 modesty panel (10in / 254mm high) on right (default) add suffix MMR to product code. i.e. COR-3618-CLR-MMR or SML on the left i.e. COR-3618-CLR-MML

**Curved Corner Unit - (COR) Links Center - 18"**



Corner unit with one narrow connecting side panel on each side. Links left and right to connecting 18" work surfaces. Curved shape accommodates full keyboard. Wire grommet included.

COR-3618-CLC	772	36/914	36/914	29/737	5/0.14	92/42
--------------	-----	--------	--------	--------	--------	-------

For optional 3/4 modesty panel (18in / 455mm high) on right (default) add suffix SMR to product code. i.e. COR-3618-CLC-SMR or SML on the left i.e. COR-3618-CLC-SML

For optional 1/4 modesty panel (10in / 254mm high) on right (default) add suffix MMR to product code. i.e. COR-3618-CLC-MMR or SML on the left i.e. COR-3618-CLC-MML

For additional specification instructions see page 6. Desk components can be found on page 123. Refer to pages 130-131 for electrical options and pages 132-133 for power/data, grommet placement options. See page 126 for keyboards and accessories. Divider panel sets and components available starting on page 102.

**Corner Unit - (COR) Links Free - 24"**

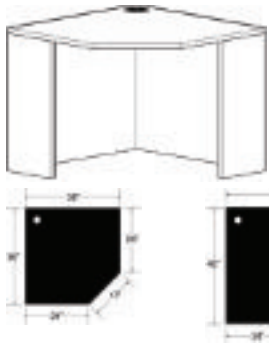

Links free, non-connecting corner unit, two narrow finished side panels. Mitred shape accommodates full keyboard. Wire grommet included.

CODE	PRICE	WIDTH (in/mm)	DEPTH (in/mm)	HEIGHT (in/mm)	VOLUME (ft3/m3)	WEIGHT (lbs/kg)
------	-------	---------------	---------------	----------------	-----------------	-----------------

COR-3624-KLF	786	36/914	36/914	29/737	5/0.14	92/42
COR-4224-KLF	797	42/1067	42/1067	29/737	5/0.14	92/42
COR-4824-KLF	866	48/1219	48/1219	29/737	5/0.14	128/58

For optional 3/4 modesty panel (18in / 455mm high) on right (default) add suffix SMR to product code. i.e. COR-3624-KLF-SMR or SML on the left i.e. COR-3624-KLF-SML

For optional 1/4 modesty panel (10in / 254mm high) on right (default) add suffix MMR to product code. i.e. COR-3624-KLF-MMR or SML on the left i.e. COR-3624-KLF-MML

**Corner Unit - (COR) Links Left - 24"**

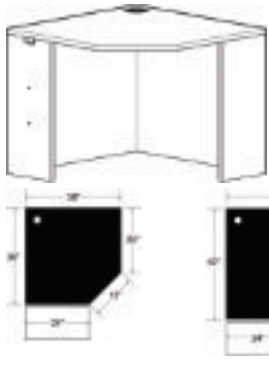

Corner unit with one narrow connecting side panel on left side and one finished side panel on right side. Links left to connecting 24" work surface. Mitred shape accommodates full keyboard. Wire grommet included.

COR-3624-KLL	786	36/914	36/914	29/737	5/0.14	92/42
COR-4224-KLL	797	42/1067	42/1067	29/737	5/0.14	92/42
COR-4824-KLL	866	48/1219	48/1219	29/737	5/0.14	128/58

For optional 3/4 modesty panel (18in / 455mm high) on right (default) add suffix SMR to product code. i.e. COR-3624-KLL-SMR or SML on the left i.e. COR-3624-KLL-SML

For optional 1/4 modesty panel (10in / 254mm high) on right (default) add suffix MMR to product code. i.e. COR-3624-KLL-MMR or SML on the left i.e. COR-3624-KLL-MML

**Corner Unit - (COR) Links Right - 24"**

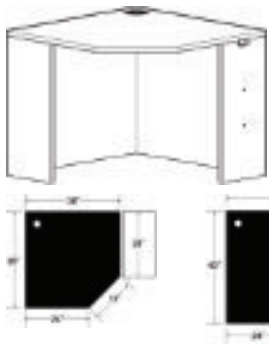

Corner unit with one narrow connecting side panel on right side and one finished side panel on left side. Links right to connecting 24" work surface. Mitred shape accommodates full keyboard. Wire grommet included.

COR-3624-KLR	786	36/914	36/914	29/737	5/0.14	92/42
COR-4224-KLR	797	42/1067	42/1067	29/737	5/0.14	92/42
COR-4824-KLR	866	48/1219	48/1219	29/737	5/0.14	128/58

For optional 3/4 modesty panel (18in / 455mm high) on right (default) add suffix SMR to product code. i.e. COR-3624-KLR-SMR or SML on the left i.e. COR-3624-KLR-SML

For optional 1/4 modesty panel (10in / 254mm high) on right (default) add suffix MMR to product code. i.e. COR-3624-KLR-MMR or SML on the left i.e. COR-3624-KLR-MML

**Corner Unit - (COR) Links Center - 24"**

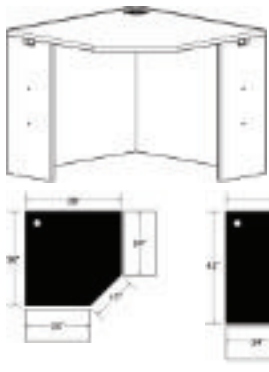

Corner unit with one narrow connecting side panel on each side. Links left and right to connecting 24" work surfaces. Mitred shape accommodates full keyboard. Wire grommet included.

COR-3624-KLC	786	36/914	36/914	29/737	5/0.14	92/42
COR-4224-KLC	797	42/1067	42/1067	29/737	5/0.14	92/42
COR-4824-KLC	866	48/1219	48/1219	29/737	5/0.14	128/58

For optional 3/4 modesty panel (18in / 455mm high) on right (default) add suffix SMR to product code. i.e. COR-3624-KLC-SMR or SML on the left i.e. COR-3624-KLC-SML

For optional 1/4 modesty panel (10in / 254mm high) on right (default) add suffix MMR to product code. i.e. COR-3624-KLC-MMR or SML on the left i.e. COR-3624-KLC-MML

For additional specification instructions see page 6. Desk components can be found on page 123. Refer to pages 130-131 for electrical options and pages 132-133 for power/data, grommet placement options. See page 126 for keyboards and accessories. Divider panel sets and components available starting on page 102.



**Curved Corner Unit - (COR) Links Free - 24"**



Links free, non-connecting corner unit, two narrow finished side panels. Curved shape accommodates full keyboard. Wire grommet included.

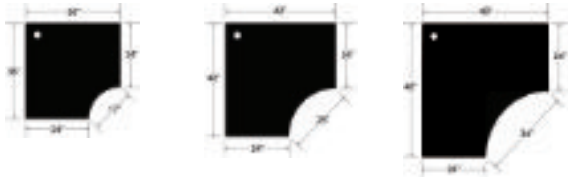

**Curved Corner Unit - (COR) Links Left - 24"**



Corner unit with one narrow connecting side panel on left side and one finished side panel on right side. Links left to connecting 24" work surface. Curved shape accommodates full keyboard. Wire grommet included.

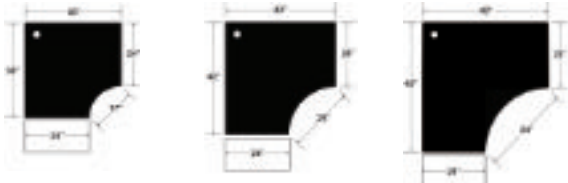

**Curved Corner Unit - (COR) Links Right - 24"**



Corner unit with one narrow connecting side panel on right side and one finished side panel on left side. Links right to connecting 24" work surface. Curved shape accommodates full keyboard. Wire grommet included.



**Curved Corner Unit - (COR) Links Center - 24"**



Corner unit with one narrow connecting side panel on each side. Links left and right to connecting 24" work surfaces. Curved shape accommodates full keyboard. Wire grommet included.

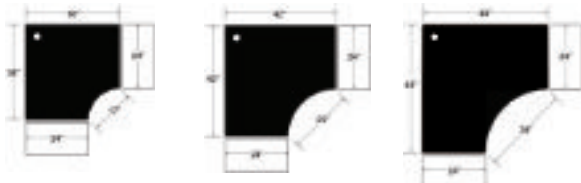

CODE	PRICE	WIDTH (in/mm)	DEPTH (in/mm)	HEIGHT (in/mm)	VOLUME (ft3/m3)	WEIGHT (lbs/kg)
------	-------	---------------	---------------	----------------	-----------------	-----------------

COR-3624-CLF	786	36/914	36/914	29/737	5/0.14	92/42
COR-4224-CLF	797	42/1067	42/1067	29/737	5/0.14	92/42
COR-4824-CLF	866	48/1219	48/1219	29/737	5/0.14	128/58

For optional 3/4 modesty panel (18in / 455mm high) on right (default) add suffix SMR to product code. i.e. COR-3624-CLF-SMR or SML on the left i.e. COR-3624-CLF-SML

For optional 1/4 modesty panel (10in / 254mm high) on right (default) add suffix MMR to product code. i.e. COR-3624-CLF-MMR or SML on the left i.e. COR-3624-CLF-MML

COR-3624-CLL	786	36/914	36/914	29/737	5/0.14	92/42
COR-4224-CLL	797	42/1067	42/1067	29/737	5/0.14	92/42
COR-4824-CLL	866	48/1219	48/1219	29/737	5/0.14	128/58

For optional 3/4 modesty panel (18in / 455mm high) on right (default) add suffix SMR to product code. i.e. COR-3624-CLL-SMR or SML on the left i.e. COR-3624-CLL-SML

For optional 1/4 modesty panel (10in / 254mm high) on right (default) add suffix MMR to product code. i.e. COR-3624-CLL-MMR or SML on the left i.e. COR-3624-CLL-MML

COR-3624-CLR	786	36/914	36/914	29/737	5/0.14	92/42
COR-4224-CLR	797	42/1067	42/1067	29/737	5/0.14	92/42
COR-4824-CLR	866	48/1219	48/1219	29/737	5/0.14	128/58

For optional 3/4 modesty panel (18in / 455mm high) on right (default) add suffix SMR to product code. i.e. COR-3624-CLR-SMR or SML on the left i.e. COR-3624-CLR-SML

For optional 1/4 modesty panel (10in / 254mm high) on right (default) add suffix MMR to product code. i.e. COR-3624-CLR-MMR or SML on the left i.e. COR-3624-CLR-MML

COR-3624-CLC	786	36/914	36/914	29/737	5/0.14	92/42
COR-4224-CLC	797	42/1067	42/1067	29/737	5/0.14	92/42
COR-4824-CLC	866	48/1219	48/1219	29/737	5/0.14	128/58

For optional 3/4 modesty panel (18in / 455mm high) on right (default) add suffix SMR to product code. i.e. COR-3624-CLC-SMR or SML on the left i.e. COR-3624-CLC-SML

For optional 1/4 modesty panel (10in / 254mm high) on right (default) add suffix MMR to product code. i.e. COR-3624-CLC-MMR or SML on the left i.e. COR-3624-CLC-MML

For additional specification instructions see page 6. Desk components can be found on page 123. Refer to pages 130-131 for electrical options and pages 132-133 for power/data, grommet placement options. See page 126 for keyboards and accessories. Divider panel sets and components available starting on page 102.



Corner Unit - (COR) Links Free - 30"



Links free, non-connecting corner unit, two narrow finished side panels. Mitred shape accommodates full keyboard. Wire grommet included.

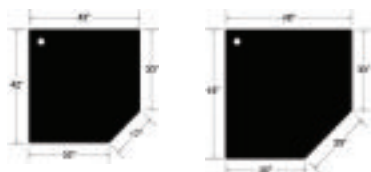

CODE	PRICE	WIDTH (in/mm)	DEPTH (in/mm)	HEIGHT (in/mm)	VOLUME (ft <sup>3</sup> /m <sup>3</sup> )	WEIGHT (lbs/kg)
------	-------	---------------	---------------	----------------	---	-----------------

COR-4230-KLF	836	42/1067	42/1067	29/737	5/0.14	118/54
COR-4830-KLF	866	48/1219	48/1219	29/737	5/0.14	128/58

For optional 3/4 modesty panel (18in / 455mm high) on right (default) add suffix SMR to product code. i.e. COR-4230-KLF-SMR or SML on the left i.e. COR-4230-KLF-SML

For optional 1/4 modesty panel (10in / 254mm high) on right (default) add suffix MMR to product code. i.e. COR-4230-KLF-MMR or SML on the left i.e. COR-4230-KLF-MML

Corner Unit - (COR) Links Left - 30"



Corner unit with one narrow connecting side panel on left side and one finished side panel on right side. Links left to connecting 30" work surface. Mitred shape accommodates full keyboard. Wire grommet included.

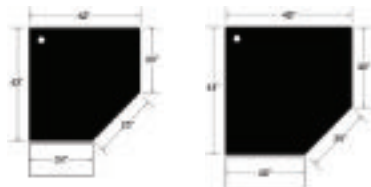

COR-4230-KLL	836	42/1067	42/1067	29/737	5/0.14	118/54
COR-4830-KLL	866	48/1219	48/1219	29/737	5/0.14	128/58

For optional 3/4 modesty panel (18in / 455mm high) on right (default) add suffix SMR to product code. i.e. COR-4230-KLL-SMR or SML on the left i.e. COR-4230-KLL-SML

For optional 1/4 modesty panel (10in / 254mm high) on right (default) add suffix MMR to product code. i.e. COR-4230-KLL-MMR or SML on the left i.e. COR-4230-KLL-MML

Corner Unit - (COR) Links Right - 30"



Corner unit with one narrow connecting side panel on right side and one finished side panel on left side. Links right to connecting 30" work surface. Mitred shape accommodates full keyboard. Wire grommet included.

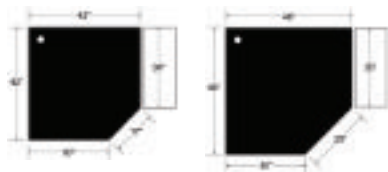

COR-4230-KLR	836	42/1067	42/1067	29/737	5/0.14	118/54
COR-4830-KLR	866	48/1219	48/1219	29/737	5/0.14	128/58

For optional 3/4 modesty panel (18in / 455mm high) on right (default) add suffix SMR to product code. i.e. COR-4230-KLR-SMR or SML on the left i.e. COR-4230-KLR-SML

For optional 1/4 modesty panel (10in / 254mm high) on right (default) add suffix MMR to product code. i.e. COR-4230-KLR-MMR or SML on the left i.e. COR-4230-KLR-MML

Corner Unit - (COR) Links Center - 30"



Corner unit with one narrow connecting side panel on each side. Links left and right to connecting 30" work surfaces. Mitred shape accommodates full keyboard. Wire grommet included.

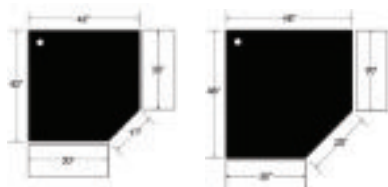

COR-4230-KLC	836	42/1067	42/1067	29/737	5/0.14	118/54
COR-4830-KLC	866	48/1219	48/1219	29/737	5/0.14	128/58

For optional 3/4 modesty panel (18in / 455mm high) on right (default) add suffix SMR to product code. i.e. COR-4230-KLC-SMR or SML on the left i.e. COR-4230-KLC-SML

For optional 1/4 modesty panel (10in / 254mm high) on right (default) add suffix MMR to product code. i.e. COR-4230-KLC-MMR or SML on the left i.e. COR-4230-KLC-MML

For additional specification instructions see page 6. Desk components can be found on page 123.

Refer to pages 130-131 for electrical options and pages 132-133 for power/data, grommet placement options.

See page 126 for keyboards and accessories. Divider panel sets and components available starting on page 102.

**Curved Corner Unit - (COR) Links Free - 30"**



Links free, non-connecting corner unit, two narrow finished side panels. Curved shape accommodates full keyboard. Wire grommet included.

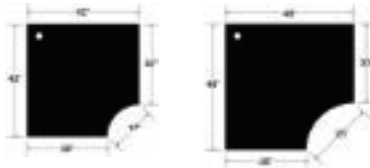

**Curved Corner Unit - (COR) Links Left - 30"**



Corner unit with one narrow connecting side panel on left side and one finished side panel on right side. Links left to connecting 30" work surface. Curved shape accommodates full keyboard. Wire grommet included.

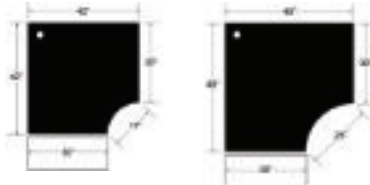

**Curved Corner Unit - (COR) Links Right - 30"**



Corner unit with one narrow connecting side panel on right side and one finished side panel on left side. Links right to connecting 30" work surface. Curved shape accommodates full keyboard. Wire grommet included.

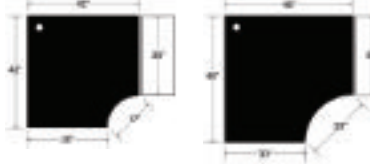

**Curved Corner Unit - (COR) Links Center - 30"**



Corner unit with one narrow connecting side panel on each side. Links left and right to connecting 30" work surfaces. Curved shape accommodates full keyboard. Wire grommet included.

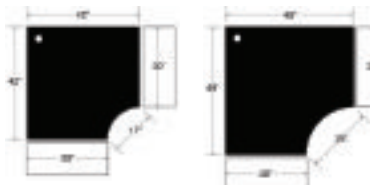

CODE	PRICE	WIDTH (in/mm)	DEPTH (in/mm)	HEIGHT (in/mm)	VOLUME (ft <sup>3</sup> /m <sup>3</sup> )	WEIGHT (lbs/kg)
------	-------	---------------	---------------	----------------	---	-----------------

COR-4230-CLF	836	42/1067	42/1067	29/737	5/0.14	118/54
COR-4830-CLF	866	48/1219	48/1219	29/737	5/0.14	128/58

For optional 3/4 modesty panel (18in / 455mm high) on right (default) add suffix SMR to product code. i.e. COR-4230-CLF-SMR or SML on the left i.e. COR-4230-CLF-SML

For optional 1/4 modesty panel (10in / 254mm high) on right (default) add suffix MMR to product code. i.e. COR-4230-CLF-MMR or SML on the left i.e. COR-4230-CLF-MML

COR-4230-CLL	836	42/1067	42/1067	29/737	5/0.14	118/54
COR-4830-CLL	866	48/1219	48/1219	29/737	5/0.14	128/58

For optional 3/4 modesty panel (18in / 455mm high) on right (default) add suffix SMR to product code. i.e. COR-4230-CLL-SMR or SML on the left i.e. COR-4230-CLL-SML

For optional 1/4 modesty panel (10in / 254mm high) on right (default) add suffix MMR to product code. i.e. COR-4230-CLL-MMR or SML on the left i.e. COR-4230-CLL-MML

COR-4230-CLR	836	42/1067	42/1067	29/737	5/0.14	118/54
COR-4830-CLR	866	48/1219	48/1219	29/737	5/0.14	128/58

For optional 3/4 modesty panel (18in / 455mm high) on right (default) add suffix SMR to product code. i.e. COR-4230-CLR-SMR or SML on the left i.e. COR-4230-CLR-SML

For optional 1/4 modesty panel (10in / 254mm high) on right (default) add suffix MMR to product code. i.e. COR-4230-CLR-MMR or SML on the left i.e. COR-4230-CLR-MML

COR-4230-CLC	836	42/1067	42/1067	29/737	5/0.14	118/54
COR-4830-CLC	866	48/1219	48/1219	29/737	5/0.14	128/58

For optional 3/4 modesty panel (18in / 455mm high) on right (default) add suffix SMR to product code. i.e. COR-4230-CLC-SMR or SML on the left i.e. COR-4230-CLC-SML

For optional 1/4 modesty panel (10in / 254mm high) on right (default) add suffix MMR to product code. i.e. COR-4230-CLC-MMR or SML on the left i.e. COR-4230-CLC-MML

For additional specification instructions see page 6. Desk components can be found on page 123. Refer to pages 130-131 for electrical options and pages 132-133 for power/data, grommet placement options. See page 126 for keyboards and accessories. Divider panel sets and components available starting on page 102.

**Corner Unit - (COR) Links Left**



Corner unit with one narrow connecting side panel on left and one narrow finished side panel on right side. Links left to connecting 24" or 30" work surface. Wire grommet included.

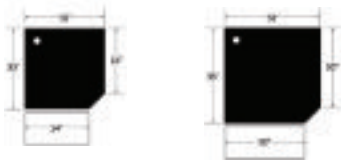

CODE	PRICE	WIDTH (in/mm)	DEPTH (in/mm)	HEIGHT (in/mm)	VOLUME (ft3/m3)	WEIGHT (lbs/kg)
------	-------	---------------	---------------	----------------	-----------------	-----------------

COR-3024-LL	696	30/762	30/762	29/737	3/0.08	70/32
COR-3630-LL	742	36/914	36/914	29/737	3/0.08	90/41

For optional 3/4 modesty panel (18in / 455mm high) on right (default) add suffix SMR to product code. i.e. COR-3024-LL-SMR or SML on the left i.e. COR-3024-LL-SML

For optional 1/4 modesty panel (10in / 254mm high) on right (default) add suffix MMR to product code. i.e. COR-3024-LL-MMR or SML on the left i.e. COR-3024-LL-MML

**Corner Unit - (COR) Links Right**



Corner unit with one narrow connecting side panel on right and one narrow finished side panel on left side. Links left to connecting 24" or 30" work surface. Wire grommet included.

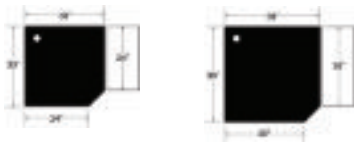

COR-3024-LR	696	30/762	30/762	29/737	3/0.08	70/32
COR-3630-LR	742	36/914	36/914	29/737	3/0.08	90/41

For optional 3/4 modesty panel (18in / 455mm high) on right (default) add suffix SMR to product code. i.e. COR-3024-LR-SMR or SML on the left i.e. COR-3024-LR-SML

For optional 1/4 modesty panel (10in / 254mm high) on right (default) add suffix MMR to product code. i.e. COR-3024-LR-MMR or SML on the left i.e. COR-3024-LR-MML

**Corner Unit - (COR) Links Center**



Corner unit with one narrow connecting side panel on each side. Links left and right to connecting 24" or 30" work surfaces. Wire grommet included.

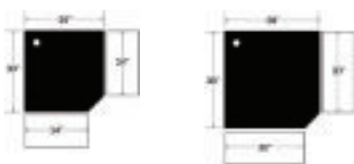

COR-3024-LC	696	30/762	30/762	29/737	3/0.08	70/32
COR-3630-LC	742	36/914	36/914	29/737	3/0.08	90/41

For optional 3/4 modesty panel (18in / 455mm high) on right (default) add suffix SMR to product code. i.e. COR-3024-LC-SMR or SML on the left i.e. COR-3024-LC-SML

For optional 1/4 modesty panel (10in / 254mm high) on right (default) add suffix MMR to product code. i.e. COR-3024-LC-MMR or SML on the left i.e. COR-3024-LC-MML

For additional specification instructions see page 6. Desk components can be found on page 123. Refer to pages 130-131 for electrical options and pages 132-133 for power/data, grommet placement options. Divider panel sets and components available starting on page 102.





CODE	PRICE	WIDTH (in/mm)	DEPTH (in/mm)	HEIGHT (in/mm)	VOLUME (ft <sup>3</sup> /m <sup>3</sup> )	WEIGHT (lbs/kg)
------	-------	------------------	------------------	-------------------	--	--------------------

**Multi Dimensional Corner Unit w/ Keyboard Edge**



Multi-dimensional corner unit with two narrow connecting side panels. Links right to 24" work surface and left to 30" work surface. Unit can be enclosed on 24" or 30" side with an optional finished narrow side panel. Mitred edge accommodates full keyboard shelf. Wire grommet included.



COR-4248-KR24L30	836	42/1067	48/1219	29/737	5/0.14	121/55
------------------	-----	---------	---------	--------	--------	--------

For optional 3/4 modesty panel (18in / 455mm high) on right (default) add suffix SMR to product code. i.e. COR-4248-KR24L30-SMR or SML on the left i.e. COR-4248-KR24L30-SML

For optional 1/4 modesty panel (10in / 254mm high) on right (default) add suffix MMR to product code. i.e. COR-4248-KR24L30-MMR or SML on the left i.e. COR-4248-KR24L30-MML

Multi-dimensional corner unit as above with curved keyboard shape.



COR-4248-CR24L30	836	42/1067	48/1219	29/737	5/0.14	121/55
------------------	-----	---------	---------	--------	--------	--------

For optional 3/4 modesty panel (18in / 455mm high) on right (default) add suffix SMR to product code. i.e. COR-4248-CR24L30-SMR or SML on the left i.e. COR-4248-CR24L30-SML

For optional 1/4 modesty panel (10in / 254mm high) on right (default) add suffix MMR to product code. i.e. COR-4248-CR24L30-MMR or SML on the left i.e. COR-4248-CR24L30-MML

Multi-dimensional corner unit with two narrow connecting side panels. Links left to 24" work surface and right to 30" work surface. Unit can be enclosed on 24" or 30" side with an optional finished narrow side panel. Mitred edge accommodates full keyboard shelf. Wire grommet included.

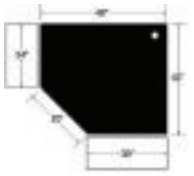

COR-4842-KR30L24	836	48/1219	42/1067	29/737	5/0.14	121/55
------------------	-----	---------	---------	--------	--------	--------

For optional 3/4 modesty panel (18in / 455mm high) on right (default) add suffix SMR to product code. i.e. COR-4842-KR30L24-SMR or SML on the left i.e. COR-4842-KR30L24-SML

For optional 1/4 modesty panel (10in / 254mm high) on right (default) add suffix MMR to product code. i.e. COR-4842-KR30L24-MMR or SML on the left i.e. COR-4842-KR30L24-MML

Multi-dimensional corner unit as above with curved keyboard shape.

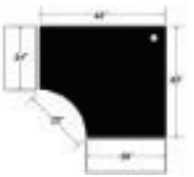

COR-4842-CR30L24	836	48/1219	42/1067	29/737	5/0.14	121/55
------------------	-----	---------	---------	--------	--------	--------

For optional 3/4 modesty panel (18in / 455mm high) on right (default) add suffix SMR to product code. i.e. COR-4842-CR30L24-SMR or SML on the left i.e. COR-4842-CR30L24-SML

For optional 1/4 modesty panel (10in / 254mm high) on right (default) add suffix MMR to product code. i.e. COR-4842-CR30L24-MMR or SML on the left i.e. COR-4842-CR30L24-MML

For additional specification instructions see page 6. Desk components can be found on page 123.  
 Refer to pages 130-131 for electrical options and pages 132-133 for power/data, grommet placement options.  
 See page 126 for keyboards and accessories. Divider panel sets and components available starting on page 102.



**Multi Dimensional Corner Unit (COR)**



Multi-dimensional corner unit with two narrow connecting side panels. Links left to 24" work surface and right to 30" work surface. Unit can be enclosed on 24" or 30" side with an optional finished narrow side panel. Wire grommet included.

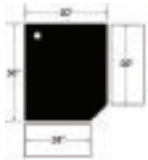

Multi-dimensional corner unit with two narrow connecting side panels. Links right to 24" work surface and left to 30" work surface. Unit can be enclosed on 24" or 30" side with an optional finished narrow side panel. Wire grommet included.

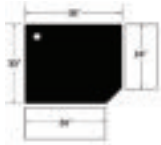

CODE	PRICE	WIDTH (in/mm)	DEPTH (in/mm)	HEIGHT (in/mm)	VOLUME (ft3/m3)	WEIGHT (lbs/kg)
------	-------	------------------	------------------	-------------------	--------------------	--------------------

<b>COR-3630-R30L24</b>	<b>797</b>	<b>36/914</b>	<b>30/762</b>	<b>29/737</b>	<b>3/0.08</b>	<b>80/36</b>
For optional 3/4 modesty panel (18in / 455mm high) on right (default) add suffix SMR to product code. i.e. COR-3630-R30L24-SMR or SML on the left i.e. COR-3630-R30L24-SML						
For optional 1/4 modesty panel (10in / 254mm high) on right (default) add suffix MMR to product code. i.e. COR-3630-R30L24-MMR or SML on the left i.e. COR-3630-R30L24-MML						

<b>COR-3036-R24L30</b>	<b>797</b>	<b>30/762</b>	<b>36/914</b>	<b>29/737</b>	<b>3/0.08</b>	<b>80/36</b>
For optional 3/4 modesty panel (18in / 455mm high) on right (default) add suffix SMR to product code. i.e. COR-3036-R24L30-SMR or SML on the left i.e. COR-3036-R24L30-SML						
For optional 1/4 modesty panel (10in / 254mm high) on right (default) add suffix MMR to product code. i.e. COR-3036-R24L30-MMR or SML on the left i.e. COR-3036-R24L30-MML						

For additional specification instructions see page 6. Desk components can be found on page 123. Refer to pages 130-131 for electrical options and pages 132-133 for power/data, grommet placement options. Divider panel sets and components available starting on page 102.

## 6 sided keyboard corner units (angled)

INTER-LINKS<sup>®</sup> by



### Corner Unit - (ACU) Links Free - 24"



Links free, non connecting corner unit, two narrow finished side panels. Mitred shape accommodates full keyboard. Wire grommet included.



CODE	PRICE	WIDTH (in/mm)	DEPTH (in/mm)	HEIGHT (in/mm)	VOLUME (ft <sup>3</sup> /m <sup>3</sup> )	WEIGHT (lbs/kg)
------	-------	------------------	------------------	-------------------	--	--------------------

ACU-4224-KLF	797	42/1067	42/1067	29/737	5/0.14	92/42
--------------	-----	---------	---------	--------	--------	-------

### Corner Unit - (ACU) Links Left - 24"



Corner unit with one narrow connecting side panel on left and one narrow finished side panel on right side. Links left to connecting 24" work surface. Mitred shape accommodates full keyboard. Wire grommet included.

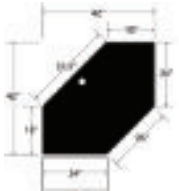

ACU-4224-KLL	797	42/1067	42/1067	29/737	5/0.14	92/42
--------------	-----	---------	---------	--------	--------	-------

### Corner Unit - (ACU) Links Right - 24"



Corner unit with one narrow connecting side panel on right and one narrow finished side panel on left side. Links right to connecting 24" work surface. Mitred shape accommodates full keyboard. Wire grommet included.

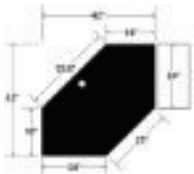

ACU-4224-KLR	797	42/1067	42/1067	29/737	5/0.14	92/42
--------------	-----	---------	---------	--------	--------	-------

### Corner Unit - (ACU) Links Center - 24"



Corner unit with one narrow connecting side panel on each side. Links left and right to connecting 24" work surfaces. Mitred shape accommodates full keyboard. Wire grommet included.



ACU-4224-KLC	797	42/1067	42/1067	29/737	5/0.14	92/42
--------------	-----	---------	---------	--------	--------	-------

For additional specification instructions see page 6. Desk components can be found on page 123. Refer to pages 130-131 for electrical options and pages 132-133 for power/data, grommet placement options. See page 126 for keyboards and accessories. Divider panel sets and components available starting on page 102.

# 6 sided keyboard corner units (angled)

## Curved Corner Unit - (ACU) Links Free - 24"



Links free, non connecting corner unit, two narrow finished side panels. Curved shape accommodates full keyboard. Wire grommet included.



CODE	PRICE	WIDTH (in/mm)	DEPTH (in/mm)	HEIGHT (in/mm)	VOLUME (ft3/m3)	WEIGHT (lbs/kg)
------	-------	---------------	---------------	----------------	-----------------	-----------------

ACU-4224-CLF	797	42/1067	42/1067	29/737	5/0.14	92/42
--------------	-----	---------	---------	--------	--------	-------

## Curved Corner Unit - (ACU) Links Left - 24"



Corner unit with one narrow connecting side panel on left and one narrow finished side panel on right side. Links left to connecting 24" work surface. Curved shape accommodates full keyboard. Wire grommet included.



ACU-4224-CLL	797	42/1067	42/1067	29/737	5/0.14	92/42
--------------	-----	---------	---------	--------	--------	-------

## Curved Corner Unit - (ACU) Links Right - 24"



Corner unit with one narrow connecting side panel on right and one narrow finished side panel on left side. Links right to connecting 24" work surface. Curved shape accommodates full keyboard. Wire grommet included.



ACU-4224-CLR	797	42/1067	42/1067	29/737	5/0.14	92/42
--------------	-----	---------	---------	--------	--------	-------

## Curved Corner Unit - (ACU) Links Center - 24"



Corner unit with one narrow connecting side panel on each side. Links left and right to connecting 24" work surfaces. Curved shape accommodates full keyboard. Wire grommet included.



ACU-4224-CLC	797	42/1067	42/1067	29/737	5/0.14	92/42
--------------	-----	---------	---------	--------	--------	-------

For additional specification instructions see page 6. Desk components can be found on page 123. Refer to pages 130-131 for electrical options and pages 132-133 for power/data, grommet placement options. See page 126 for keyboards and accessories. Divider panel sets and components available starting on page 102.

**Corner Unit - (ACU) Links Free - 30"**



Links free, non connecting corner unit, two narrow finished side panels. Mitred shape accommodates full keyboard. Wire grommet included.



CODE	PRICE	WIDTH (in/mm)	DEPTH (in/mm)	HEIGHT (in/mm)	VOLUME (ft3/m3)	WEIGHT (lbs/kg)
------	-------	---------------	---------------	----------------	-----------------	-----------------

ACU-4230-KLF	836	42/1067	42/1067	29/737	5/0.14	118/54
ACU-4830-KLF	866	48/1219	48/1219	29/737	5/0.14	128/58

**Corner Unit - (ACU) Links Left - 30"**



Corner unit with one narrow connecting side panel on left and one narrow finished side panel on right side. Links left to connecting 30" work surface. Mitred shape accommodates full keyboard. Wire grommet included.



ACU-4230-KLL	836	42/1067	42/1067	29/737	5/0.14	118/54
ACU-4830-KLL	866	48/1219	48/1219	29/737	5/0.14	128/58

**Corner Unit - (ACU) Links Right - 30"**



Corner unit with one narrow connecting side panel on right and one narrow finished side panel on left side. Links right to connecting 30" work surface. Mitred shape accommodates full keyboard. Wire grommet included.



ACU-4230-KLR	836	42/1067	42/1067	29/737	5/0.14	118/54
ACU-4830-KLR	866	48/1219	48/1219	29/737	5/0.14	128/58

**Corner Unit - (ACU) Links Center - 30"**



Corner unit with one narrow connecting side panel on each side. Links left and right to connecting 30" work surfaces. Mitred shape accommodates full keyboard. Wire grommet included.

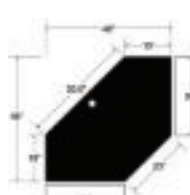

ACU-4230-KLC	836	42/1067	42/1067	29/737	5/0.14	118/54
ACU-4830-KLC	866	48/1219	48/1219	29/737	5/0.14	128/58

For additional specification instructions see page 6. Desk components can be found on page 123. Refer to pages 130-131 for electrical options and pages 132-133 for power/data, grommet placement options. See page 126 for keyboards and accessories. Divider panel sets and components available starting on page 102.

# 6 sided keyboard corner units (angled)

## Curved Corner Unit - (ACU) Links Free - 30"

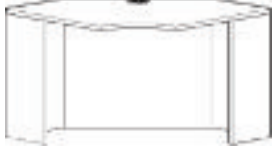

Links free, non connecting corner unit, two narrow finished side panels. Curved shape accommodates full keyboard. Wire grommet included.

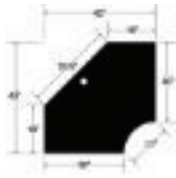

CODE	PRICE	WIDTH (in/mm)	DEPTH (in/mm)	HEIGHT (in/mm)	VOLUME (ft3/m3)	WEIGHT (lbs/kg)
------	-------	------------------	------------------	-------------------	--------------------	--------------------

ACU-4230-CLF	836	42/1067	42/1067	29/737	5/0.14	118/54
ACU-4830-CLF	866	48/1219	48/1219	29/737	5/0.14	128/58

## Curved Corner Unit - (ACU) Links Left - 30"



Corner unit with one narrow connecting side panel on left and one narrow finished side panel on right side. Links left to connecting 30" work surface. Curved shape accommodates full keyboard. Wire grommet included.

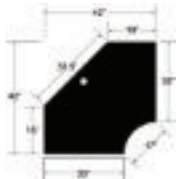

ACU-4230-CLL	836	42/1067	42/1067	29/737	5/0.14	118/54
ACU-4830-CLL	866	48/1219	48/1219	29/737	5/0.14	128/58

## Curved Corner Unit - (ACU) Links Right - 30"



Corner unit with one narrow connecting side panel on right and one narrow finished side panel on left side. Links right to connecting 30" work surface. Curved shape accommodates full keyboard. Wire grommet included.



ACU-4230-CLR	836	42/1067	42/1067	29/737	5/0.14	118/54
ACU-4830-CLR	866	48/1219	48/1219	29/737	5/0.14	128/58

## Curved Corner Unit - (ACU) Links Center - 30"

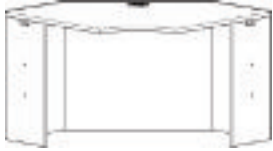

Corner unit with one narrow connecting side panel on each side. Links left and right to connecting 30" work surfaces. Curved shape accommodates full keyboard. Wire grommet included.



ACU-4230-CLC	836	42/1067	42/1067	29/737	5/0.14	118/54
ACU-4830-CLC	866	48/1219	48/1219	29/737	5/0.14	128/58

For additional specification instructions see page 6. Desk components can be found on page 123. Refer to pages 130-131 for electrical options and pages 132-133 for power/data, grommet placement options. See page 126 for keyboards and accessories. Divider panel sets and components available starting on page 102.



CODE	PRICE	WIDTH (in/mm)	DEPTH (in/mm)	HEIGHT (in/mm)	VOLUME (ft3/m3)	WEIGHT (lbs/kg)
------	-------	------------------	------------------	-------------------	--------------------	--------------------

**Corner Unit - (ACU) 130 Degree Angle**



Corner unit with one narrow connecting side panel each side. Links left and right to connecting 24" work surfaces. Mitred shape accommodates full keyboard. Wire grommet included.

ACU-6060-KLC	1036	60/1524	27/686	29/737	9/0.25	120/54
--------------	------	---------	--------	--------	--------	--------



**Curved Corner Unit - (ACU) 130 Degree Angle**







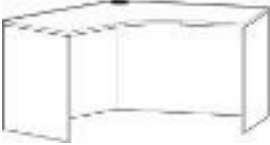
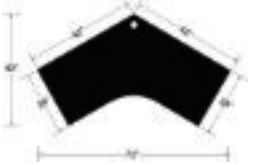

Corner unit with one narrow connecting side panel each side. Links left and right to connecting 24" work surfaces. Curved shape accommodates full keyboard. Wire grommet included.

ACU-6060-CLC	1036	60/1524	27/686	29/737	9/0.25	120/54
--------------	------	---------	--------	--------	--------	--------



For additional specification instructions see page 6. Desk components can be found on page 123. Refer to pages 130-131 for electrical options and pages 132-133 for power/data, grommet placement options. See page 126 for keyboards and accessories. Divider panel sets and components available starting on page 102.

		WIDTH	DEPTH	HEIGHT	VOLUME	WEIGHT		
CODE	PRICE	(in/mm)	(in/mm)	(in/mm)	(ft <sup>3</sup> /m <sup>3</sup> )	(lbs/kg)		
<b>Curved Corner Unit - (ACU) 120 Degree Angle</b>								
 	<p>Corner unit with one full side panel each side. Curved shape accommodates full keyboard. Wire grommet included.</p>	ACU-4242-120-CLF	1036	42/1067	42/1067	29/737	9/0.25	120/54
 	<p>Corner unit with one full side panel and one narrow connecting side panel. Links left to connecting 24" work surface. Curved shape accommodates full keyboard. Wire grommet included.</p>	ACU-4242-120-CLL	1036	42/1067	42/1067	29/737	9/0.25	120/54
 	<p>Corner unit with one full side panel and one narrow connecting side panel. Links right to connecting 24" work surface. Curved shape accommodates full keyboard. Wire grommet included.</p>	ACU-4242-120-CLR	1036	42/1067	42/1067	29/737	9/0.25	120/54
 	<p>Corner unit with one narrow connecting side panel each side. Links left and right to connecting 24" work surfaces. Curved shape accommodates full keyboard. Wire grommet included.</p>	ACU-4242-120-CLC	1036	42/1067	42/1067	29/737	9/0.25	120/54

For additional specification instructions see page 6. Desk components can be found on page 123. Refer to pages 130-131 for electrical options and pages 132-133 for power/data, grommet placement options. See page 126 for keyboards and accessories. Divider panel sets and components available starting on page 102.

**Extended Corner Unit Left - (ECU) 24"**



Corner unit on left side, extension on right side, non connecting work surface with two side panels. Wire grommet included.

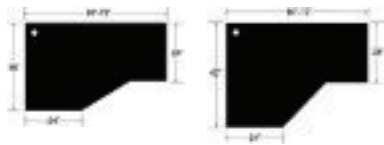

Corner unit on left side with narrow connecting side panel, extension on right side with full side panel. Links left to connecting 24" work surface. Wire grommet included.

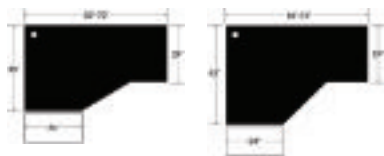

Corner unit on left side, extension on right side with narrow connecting side panel. Links right to connecting 24" work surface. Wire grommet included.

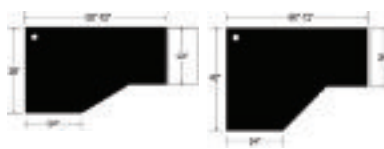

Corner unit on left side and extension on right side, each with narrow connecting side panel. Links right and left to connecting 24" work surface. Wire grommet included.

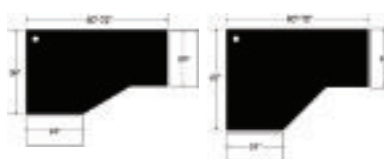

CODE	PRICE	WIDTH (in/mm)	DEPTH (in/mm)	HEIGHT (in/mm)	VOLUME (ft3/m3)	WEIGHT (lbs/kg)
------	-------	---------------	---------------	----------------	-----------------	-----------------

ECU-2460-KLLF	1072	60/1524	36/914	29/737	6/0.17	130/59
ECU-2466-KLLF	1104	66/1676	36/914	29/737	7/0.20	136/62
ECU-2472-KLLF	1138	72/1829	36/914	29/737	8/0.23	142/64
ECU-2460-42-KLLF	1223	60/1524	42/1067	29/737	7/0.20	160/73
ECU-2466-42-KLLF	1244	66/1676	42/1067	29/737	8/0.23	170/77
ECU-2472-42-KLLF	1260	72/1829	42/1067	29/737	9/0.25	180/82

For optional 3/4 modesty panel (18in / 455mm high) add suffix SM to product code. i.e. ECU-2472-KLLF-SM

For optional 1/4 modesty panel (10in / 254mm high) add suffix MM to product code. i.e. ECU-2472-KLLF-MM

ECU-2460-KLLL	1072	60/1524	36/914	29/737	6/0.17	130/59
ECU-2466-KLLL	1104	66/1676	36/914	29/737	7/0.20	136/62
ECU-2472-KLLL	1138	72/1829	36/914	29/737	8/0.23	142/64
ECU-2460-42-KLLL	1223	60/1524	42/1067	29/737	7/0.20	160/73
ECU-2466-42-KLLL	1244	66/1676	42/1067	29/737	8/0.23	170/77
ECU-2472-42-KLLL	1260	72/1829	42/1067	29/737	9/0.25	180/82

For optional 3/4 modesty panel (18in / 455mm high) add suffix SM to product code. i.e. ECU-2472-KLLL-SM

For optional 1/4 modesty panel (10in / 254mm high) add suffix MM to product code. i.e. ECU-2472-KLLL-MM

ECU-2460-KLLR	1072	60/1524	36/914	29/737	6/0.17	125/57
ECU-2466-KLLR	1104	66/1676	36/914	29/737	7/0.20	130/59
ECU-2472-KLLR	1138	72/1829	36/914	29/737	8/0.23	135/61
ECU-2460-42-KLLR	1223	60/1524	42/1067	29/737	7/0.20	160/73
ECU-2466-42-KLLR	1244	66/1676	42/1067	29/737	8/0.23	170/77
ECU-2472-42-KLLR	1260	72/1829	42/1067	29/737	9/0.25	180/82

For optional 3/4 modesty panel (18in / 455mm high) add suffix SM to product code. i.e. ECU-2472-KLLR-SM

For optional 1/4 modesty panel (10in / 254mm high) add suffix MM to product code. i.e. ECU-2472-KLLR-MM

ECU-2460-KLLC	1072	60/1524	36/914	29/737	6/0.17	125/57
ECU-2466-KLLC	1104	66/1676	36/914	29/737	7/0.20	130/59
ECU-2472-KLLC	1138	72/1829	36/914	29/737	8/0.23	135/61
ECU-2460-42-KLLC	1223	60/1524	42/1067	29/737	7/0.20	160/73
ECU-2466-42-KLLC	1244	66/1676	42/1067	29/737	8/0.23	170/77
ECU-2472-42-KLLC	1260	72/1829	42/1067	29/737	9/0.25	180/82

For optional 3/4 modesty panel (18in / 455mm high) add suffix SM to product code. i.e. ECU-2472-KLLC-SM

For optional 1/4 modesty panel (10in / 254mm high) add suffix MM to product code. i.e. ECU-2472-KLLC-MM

For additional specification instructions see page 6. Desk components can be found on page 123.  
Refer to pages 130-131 for electrical options and pages 132-133 for power/data, grommet placement options.  
See page 126 for keyboards and accessories. Divider panel sets and components available starting on page 102.

**Extended Corner Unit Left - (ECU) 24" - Curved**



Corner unit on left side, extension on right side, non connecting work surface with two side panels. Features curved cutout for keyboard. Wire grommet included.

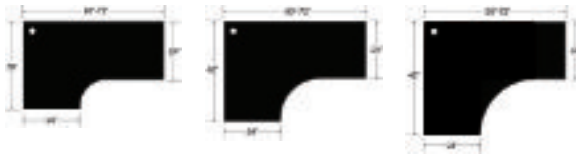

CODE	PRICE	WIDTH (in/mm)	DEPTH (in/mm)	HEIGHT (in/mm)	VOLUME (ft3/m3)	WEIGHT (lbs/kg)
------	-------	---------------	---------------	----------------	-----------------	-----------------

ECU-2460-CLLF	1072	60/1524	36/914	29/737	6/0.17	130/59
ECU-2466-CLLF	1104	66/1676	36/914	29/737	7/0.20	136/62
ECU-2472-CLLF	1138	72/1829	36/914	29/737	8/0.23	142/64
ECU-2460-42-CLLF	1223	60/1524	42/1067	29/737	7/0.20	160/73
ECU-2466-42-CLLF	1244	66/1676	42/1067	29/737	8/0.23	170/77
ECU-2472-42-CLLF	1260	72/1829	42/1067	29/737	9/0.25	180/82
ECU-2460-48-CLLF	1405	60/1524	48/1219	29/737	8/0.23	180/82
ECU-2466-48-CLLF	1432	66/1676	48/1219	29/737	9/0.25	190/86
ECU-2472-48-CLLF	1450	72/1829	48/1219	29/737	10/0.28	200/91

For optional 3/4 modesty panel (18in / 455mm high) add suffix SM to product code. i.e. ECU-2472-CLLF-SM

For optional 1/4 modesty panel (10in / 254mm high) add suffix MM to product code. i.e. ECU-2472-CLLF-MM



Corner unit on left side with narrow connecting side panel, extension on right side with full side panel. Links left to connecting 24" work surface. Features curved cutout for keyboard. Wire grommet included.

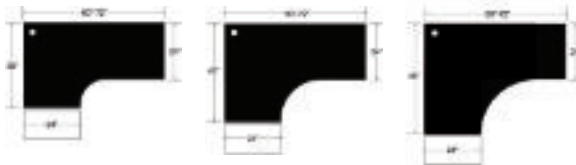

ECU-2460-CLLL	1072	60/1524	36/914	29/737	6/0.17	130/59
ECU-2466-CLLL	1104	66/1676	36/914	29/737	7/0.20	136/62
ECU-2472-CLLL	1138	72/1829	36/914	29/737	8/0.23	142/64
ECU-2460-42-CLLL	1223	60/1524	42/1067	29/737	7/0.20	160/73
ECU-2466-42-CLLL	1244	66/1676	42/1067	29/737	8/0.23	170/77
ECU-2472-42-CLLL	1260	72/1829	42/1067	29/737	9/0.25	180/82
ECU-2460-48-CLLL	1405	60/1524	48/1219	29/737	8/0.23	180/82
ECU-2466-48-CLLL	1432	66/1676	48/1219	29/737	9/0.25	190/86
ECU-2472-48-CLLL	1450	72/1829	48/1219	29/737	10/0.28	200/91

For optional 3/4 modesty panel (18in / 455mm high) add suffix SM to product code. i.e. ECU-2472-CLLL-SM

For optional 1/4 modesty panel (10in / 254mm high) add suffix MM to product code. i.e. ECU-2472-CLLL-MM



Corner unit on left side, extension on right side with narrow connecting side panel. Links right to connecting 24" work surface. Features curved cutout for keyboard. Wire grommet included.

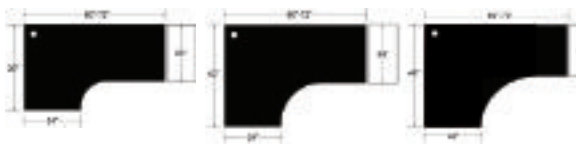

ECU-2460-CLLR	1072	60/1524	36/914	29/737	6/0.17	125/57
ECU-2466-CLLR	1104	66/1676	36/914	29/737	7/0.20	130/59
ECU-2472-CLLR	1138	72/1829	36/914	29/737	8/0.23	135/61
ECU-2460-42-CLLR	1223	60/1524	42/1067	29/737	7/0.20	160/73
ECU-2466-42-CLLR	1244	66/1676	42/1067	29/737	8/0.23	170/77
ECU-2472-42-CLLR	1260	72/1829	42/1067	29/737	9/0.25	180/82
ECU-2460-48-CLLR	1405	60/1524	48/1219	29/737	8/0.23	180/82
ECU-2466-48-CLLR	1432	66/1676	48/1219	29/737	9/0.25	190/86
ECU-2472-48-CLLR	1450	72/1829	48/1219	29/737	10/0.28	200/91

For optional 3/4 modesty panel (18in / 455mm high) add suffix SM to product code. i.e. ECU-2472-CLLR-SM

For optional 1/4 modesty panel (10in / 254mm high) add suffix MM to product code. i.e. ECU-2472-CLLR-MM

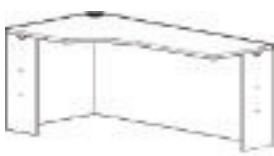

Corner unit on left side and extension on right side, each with narrow connecting side panel. Links right and left to connecting 24" work surface. Features curved cutout for keyboard. Wire grommet included.



ECU-2460-CLLC	1072	60/1524	36/914	29/737	6/0.17	125/57
ECU-2466-CLLC	1104	66/1676	36/914	29/737	7/0.20	130/59
ECU-2472-CLLC	1138	72/1829	36/914	29/737	8/0.23	135/61
ECU-2460-42-CLLC	1223	60/1524	42/1067	29/737	7/0.20	160/73
ECU-2466-42-CLLC	1244	66/1676	42/1067	29/737	8/0.23	170/77
ECU-2472-42-CLLC	1260	72/1829	42/1067	29/737	9/0.25	180/82
ECU-2460-48-CLLC	1405	60/1524	48/1219	29/737	8/0.23	180/82
ECU-2466-48-CLLC	1432	66/1676	48/1219	29/737	9/0.25	190/86
ECU-2472-48-CLLC	1450	72/1829	48/1219	29/737	10/0.28	200/91

For optional 3/4 modesty panel (18in / 455mm high) add suffix SM to product code. i.e. ECU-2472-CLLC-SM

For optional 1/4 modesty panel (10in / 254mm high) add suffix MM to product code. i.e. ECU-2472-CLLC-MM

For additional specification instructions see page 6. Desk components can be found on page 123. Refer to pages 130-131 for electrical options and pages 132-133 for power/data, grommet placement options. See page 126 for keyboards and accessories. Divider panel sets and components available starting on page 102.

**Extended Corner Unit Right- (ECU) 24"**



Corner unit on right side, extension on left side, non connecting work surface with two side panels. Wire grommet included.

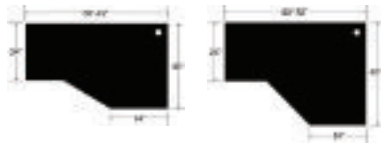

Corner unit on right side, extension on left side with narrow connecting side panel. Links left to connecting 24" work surface. Wire grommet included.

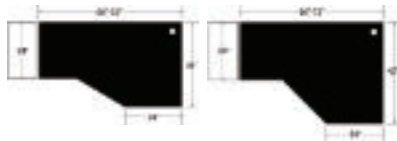

Corner unit on right side, with narrow connecting panel, extension on left side with full side panel. Links right to connecting 24" work surface. Wire grommet included.



Corner unit on right side and extension on left side, each with narrow connecting side panel. Links right and left to connecting 24" work surface. Wire grommet included.



CODE	PRICE	WIDTH (in/mm)	DEPTH (in/mm)	HEIGHT (in/mm)	VOLUME (ft3/m3)	WEIGHT (lbs/kg)
------	-------	---------------	---------------	----------------	-----------------	-----------------

ECU-2460-KRLF	1072	60/1524	36/914	29/737	6/0.17	130/59
ECU-2466-KRLF	1104	66/1676	36/914	29/737	7/0.20	136/62
ECU-2472-KRLF	1138	72/1829	36/914	29/737	8/0.23	142/64
ECU-2460-42-KRLF	1223	60/1524	42/1067	29/737	7/0.20	160/73
ECU-2466-42-KRLF	1244	66/1676	42/1067	29/737	8/0.23	170/77
ECU-2472-42-KRLF	1260	72/1829	42/1067	29/737	9/0.25	180/82

For optional 3/4 modesty panel (18in / 455mm high) add suffix SM to product code. i.e. ECU-2472-KRLF-SM

For optional 1/4 modesty panel (10in / 254mm high) add suffix MM to product code. i.e. ECU-2472-KRLF-MM

ECU-2460-KRLL	1072	60/1524	36/914	29/737	6/0.17	125/57
ECU-2466-KRLL	1104	66/1676	36/914	29/737	7/0.20	130/59
ECU-2472-KRLL	1138	72/1829	36/914	29/737	8/0.23	135/61
ECU-2460-42-KRLL	1223	60/1524	42/1067	29/737	7/0.20	160/73
ECU-2466-42-KRLL	1244	66/1676	42/1067	29/737	8/0.23	170/77
ECU-2472-42-KRLL	1260	72/1829	42/1067	29/737	9/0.25	180/82

For optional 3/4 modesty panel (18in / 455mm high) add suffix SM to product code. i.e. ECU-2472-KRLL-SM

For optional 1/4 modesty panel (10in / 254mm high) add suffix MM to product code. i.e. ECU-2472-KRLL-MM

ECU-2460-KRLR	1072	60/1524	36/914	29/737	6/0.17	130/59
ECU-2466-KRLR	1104	66/1676	36/914	29/737	7/0.20	136/62
ECU-2472-KRLR	1138	72/1829	36/914	29/737	8/0.23	142/64
ECU-2460-42-KRLR	1223	60/1524	42/1067	29/737	7/0.20	160/73
ECU-2466-42-KRLR	1244	66/1676	42/1067	29/737	8/0.23	170/77
ECU-2472-42-KRLR	1260	72/1829	42/1067	29/737	9/0.25	180/82

For optional 3/4 modesty panel (18in / 455mm high) add suffix SM to product code. i.e. ECU-2472-KRLR-SM

For optional 1/4 modesty panel (10in / 254mm high) add suffix MM to product code. i.e. ECU-2472-KRLR-MM

ECU-2460-KRLC	1072	60/1524	36/914	29/737	6/0.17	125/57
ECU-2466-KRLC	1104	66/1676	36/914	29/737	7/0.20	130/59
ECU-2472-KRLC	1138	72/1829	36/914	29/737	8/0.23	135/61
ECU-2460-42-KRLC	1223	60/1524	42/1067	29/737	7/0.20	160/73
ECU-2466-42-KRLC	1244	66/1676	42/1067	29/737	8/0.23	170/77
ECU-2472-42-KRLC	1260	72/1829	42/1067	29/737	9/0.25	180/82

For optional 3/4 modesty panel (18in / 455mm high) add suffix SM to product code. i.e. ECU-2472-KRLC-SM

For optional 1/4 modesty panel (10in / 254mm high) add suffix MM to product code. i.e. ECU-2472-KRLC-MM

For additional specification instructions see page 6. Desk components can be found on page 123.  
Refer to pages 130-131 for electrical options and pages 132-133 for power/data, grommet placement options.  
See page 126 for keyboards and accessories. Divider panel sets and components available starting on page 102.



**Extended Corner Unit Right- (ECU) 24" - Curved**



Corner unit on right side, extension on left side, non connecting work surface with two side panels. Wire grommet included. Features curved cutout for keyboard. Wire grommet included.



Corner unit on right side, extension on left side with narrow connecting side panel. Links left to connecting 24" work surface. Features curved cutout for keyboard. Wire grommet included.

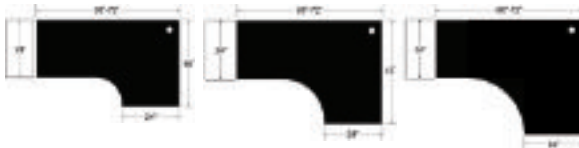

Corner unit on right side, with narrow connecting panel, extension on left side with full side panel. Links right to connecting 24" work surface. Features curved cutout for keyboard. Wire grommet included.



Corner unit on right side and extension on left side, each with narrow connecting side panel. Links right to connecting 24" work surface. Features curved cutout for keyboard. Wire grommet included.

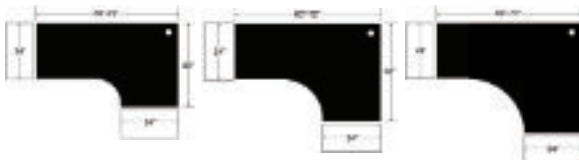

CODE	PRICE	WIDTH (in/mm)	DEPTH (in/mm)	HEIGHT (in/mm)	VOLUME (ft3/m3)	WEIGHT (lbs/kg)
------	-------	---------------	---------------	----------------	-----------------	-----------------

ECU-2460-CRLF	1072	60/1524	36/914	29/737	6/0.17	130/59
ECU-2466-CRLF	1104	66/1676	36/914	29/737	7/0.20	136/62
ECU-2472-CRLF	1138	72/1829	36/914	29/737	8/0.23	142/64
ECU-2460-42-CRLF	1223	60/1524	42/1067	29/737	7/0.20	160/73
ECU-2466-42-CRLF	1244	66/1676	42/1067	29/737	8/0.23	170/77
ECU-2472-42-CRLF	1260	72/1829	42/1067	29/737	9/0.25	180/82
ECU-2460-48-CRLF	1405	60/1524	48/1219	29/737	8/0.23	180/82
ECU-2466-48-CRLF	1432	66/1676	48/1219	29/737	9/0.25	190/86
ECU-2472-48-CRLF	1450	72/1829	48/1219	29/737	10/0.28	200/91

For optional 3/4 modesty panel (18in / 455mm high) add suffix SM to product code. i.e. ECU-2472-CRLF-SM

For optional 1/4 modesty panel (10in / 254mm high) add suffix MM to product code. i.e. ECU-2472-CRLF-MM

ECU-2460-CRLL	1072	60/1524	36/914	29/737	6/0.17	125/57
ECU-2466-CRLL	1104	66/1676	36/914	29/737	7/0.20	130/59
ECU-2472-CRLL	1138	72/1829	36/914	29/737	8/0.23	135/61
ECU-2460-42-CRLL	1223	60/1524	42/1067	29/737	7/0.20	160/73
ECU-2466-42-CRLL	1244	66/1676	42/1067	29/737	8/0.23	170/77
ECU-2472-42-CRLL	1260	72/1829	42/1067	29/737	9/0.25	180/82
ECU-2460-48-CRLL	1405	60/1524	48/1219	29/737	8/0.23	180/82
ECU-2466-48-CRLL	1432	66/1676	48/1219	29/737	9/0.25	190/86
ECU-2472-48-CRLL	1450	72/1829	48/1219	29/737	10/0.28	200/91

For optional 3/4 modesty panel (18in / 455mm high) add suffix SM to product code. i.e. ECU-2472-CRLL-SM

For optional 1/4 modesty panel (10in / 254mm high) add suffix MM to product code. i.e. ECU-2472-CRLL-MM

ECU-2460-CRLR	1072	60/1524	36/914	29/737	6/0.17	130/59
ECU-2466-CRLR	1104	66/1676	36/914	29/737	7/0.20	136/62
ECU-2472-CRLR	1138	72/1829	36/914	29/737	8/0.23	142/64
ECU-2460-42-CRLR	1223	60/1524	42/1067	29/737	7/0.20	160/73
ECU-2466-42-CRLR	1244	66/1676	42/1067	29/737	8/0.23	170/77
ECU-2472-42-CRLR	1260	72/1829	42/1067	29/737	9/0.25	180/82
ECU-2460-48-CRLR	1405	60/1524	48/1219	29/737	8/0.23	180/82
ECU-2466-48-CRLR	1432	66/1676	48/1219	29/737	9/0.25	190/86
ECU-2472-48-CRLR	1450	72/1829	48/1219	29/737	10/0.28	200/91

For optional 3/4 modesty panel (18in / 455mm high) add suffix SM to product code. i.e. ECU-2472-CRLR-SM

For optional 1/4 modesty panel (10in / 254mm high) add suffix MM to product code. i.e. ECU-2472-CRLR-MM

ECU-2460-CRLC	1072	60/1524	36/914	29/737	6/0.17	125/57
ECU-2466-CRLC	1104	66/1676	36/914	29/737	7/0.20	130/59
ECU-2472-CRLC	1138	72/1829	36/914	29/737	8/0.23	135/61
ECU-2460-42-CRLC	1223	60/1524	42/1067	29/737	7/0.20	160/73
ECU-2466-42-CRLC	1244	66/1676	42/1067	29/737	8/0.23	170/77
ECU-2472-42-CRLC	1260	72/1829	42/1067	29/737	9/0.25	180/82
ECU-2460-48-CRLC	1405	60/1524	48/1219	29/737	8/0.23	180/82
ECU-2466-48-CRLC	1432	66/1676	48/1219	29/737	9/0.25	190/86
ECU-2472-48-CRLC	1450	72/1829	48/1219	29/737	10/0.28	200/91

For optional 3/4 modesty panel (18in / 455mm high) add suffix SM to product code. i.e. ECU-2472-CRLC-SM

For optional 1/4 modesty panel (10in / 254mm high) add suffix MM to product code. i.e. ECU-2472-CRLC-MM

For additional specification instructions see page 6. Desk components can be found on page 123. Refer to pages 130-131 for electrical options and pages 132-133 for power/data, grommet placement options. See page 126 for keyboards and accessories. Divider panel sets and components available starting on page 102.

**Extended Corner Unit 30" - Links Left**



Corner unit on left side, extension on right side. Links to connecting 24" work surface. Recessed back panel. Wire grommet included.



Corner unit on left side, extension on right side. Straight keyboard edge. Links to connecting 24" work surface. Recessed back panel. Wire grommet included.



**Extended Corner Unit 30" - Links Right**



Corner unit on right side, extension on left side. Links to connecting 24" work surface. Recessed back panel. Wire grommet included.

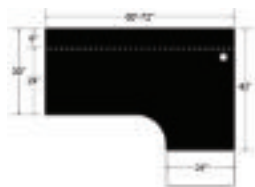

Corner unit on right side, extension on left side. Straight keyboard edge. Links to connecting 24" work surface. Recessed back panel. Wire grommet included.

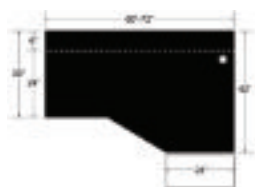

CODE	PRICE	WIDTH (in/mm)	DEPTH (in/mm)	HEIGHT (in/mm)	VOLUME (ft <sup>3</sup> /m <sup>3</sup> )	WEIGHT (lbs/kg)
------	-------	---------------	---------------	----------------	---	-----------------

ECU-3066-CLLL	1357	66/1676	42/1067	29/737	7/0.20	163/74
ECU-3072-CLLL	1409	72/1829	42/1067	29/737	8/0.23	169/77

For optional 3/4 modesty panel (18in / 455mm high) add suffix SM to product code. i.e. ECU-3072-CLLL-SM  
For optional 1/4 modesty panel (10in / 254mm high) add suffix MM to product code. i.e. ECU-3072-CLLL-MM

ECU-3066-KLLL	1357	66/1676	42/1067	29/737	7/0.20	163/74
ECU-3072-KLLL	1409	72/1829	42/1067	29/737	8/0.23	169/77

For optional 3/4 modesty panel (18in / 455mm high) add suffix SM to product code. i.e. ECU-3072-KLLL-SM  
For optional 1/4 modesty panel (10in / 254mm high) add suffix MM to product code. i.e. ECU-3072-KLLL-MM

ECU-3066-CRLR	1357	66/1676	42/1067	29/737	7/0.20	163/74
ECU-3072-CRLR	1409	72/1829	42/1067	29/737	8/0.23	169/77

For optional 3/4 modesty panel (18in / 455mm high) add suffix SM to product code. i.e. ECU-3072-CRLR-SM  
For optional 1/4 modesty panel (10in / 254mm high) add suffix MM to product code. i.e. ECU-3072-CRLR-MM

ECU-3066-KRLR	1357	66/1676	42/1067	29/737	7/0.20	163/74
ECU-3072-KRLR	1409	72/1829	42/1067	29/737	8/0.23	169/77

For optional 3/4 modesty panel (18in / 455mm high) add suffix SM to product code. i.e. ECU-3072-KRLR-SM  
For optional 1/4 modesty panel (10in / 254mm high) add suffix MM to product code. i.e. ECU-3072-KRLR-MM

For additional specification instructions see page 6. Desk components can be found on page 123.  
Refer to pages 130-131 for electrical options and pages 132-133 for power/data, grommet placement options.  
See page 126 for keyboards and accessories. Divider panel sets and components available starting on page 102.

**Bowfront Extended Corner Unit 30" - Links Left**



Corner unit on left side, extension on right side. Links to connecting 24" work surface. Bow front top. Recessed back panel. Wire grommet included.

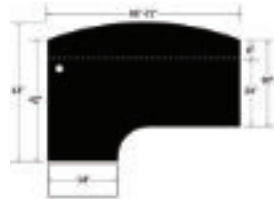
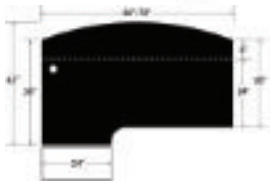

Corner unit on left side, extension on right side. Straight keyboard edge. Links to connecting 24" work surface. Bow front top. Recessed back panel. Wire grommet included.



**Bowfront Extended Corner Unit 30" - Links Right**



Corner unit on rightside, extension on left side. Links to connecting 24" work surface. Bow front top. Recessed back panel. Wire grommet included.



Corner unit on rightside, extension on left side. Straight keyboard edge. Links to connecting 24" work surface. Bow front top. Recessed back panel. Wire grommet included.



CODE	PRICE	WIDTH (in/mm)	DEPTH (in/mm)	HEIGHT (in/mm)	VOLUME (ft3/m3)	WEIGHT (lbs/kg)
------	-------	---------------	---------------	----------------	-----------------	-----------------

ECU-3066-36-BFLL	1357	66/1676	42/1067	29/737	7/0.20	153/69
ECU-3072-36-BFLL	1409	72/1829	42/1067	29/737	8/0.23	159/72
ECU-3066-42-BFLL	1631	66/1676	48/1219	29/737	8/0.23	169/77
ECU-3072-42-BFLL	1692	72/1829	48/1219	29/737	9/0.25	175/79

For optional 3/4 modesty panel (18in / 455mm high) add suffix SM to product code. i.e. ECU-3072-36-BFLL-SM  
For optional 1/4 modesty panel (10in / 254mm high) add suffix MM to product code. i.e. ECU-3072-36-BFLL-MM

ECU-3066-42-BF-KLL	1631	66/1676	48/1219	29/737	8/0.23	169/77
ECU-3072-42-BF-KLL	1692	72/1829	48/1219	29/737	9/0.25	175/79

For optional 3/4 modesty panel (18in / 455mm high) add suffix SM to product code. i.e. ECU-3072-42-BF-KLL-SM  
For optional 1/4 modesty panel (10in / 254mm high) add suffix MM to product code. i.e. ECU-3072-42-BF-KLL-MM

ECU-3066-36-BFLR	1357	66/1676	42/1067	29/737	7/0.20	153/69
ECU-3072-36-BFLR	1409	72/1829	42/1067	29/737	8/0.23	159/72
ECU-3066-42-BFLR	1631	66/1676	48/1219	29/737	8/0.23	169/77
ECU-3072-42-BFLR	1692	72/1829	48/1219	29/737	9/0.25	175/79

For optional 3/4 modesty panel (18in / 455mm high) add suffix SM to product code. i.e. ECU-3072-36-BFLR-SM  
For optional 1/4 modesty panel (10in / 254mm high) add suffix MM to product code. i.e. ECU-3072-36-BFLR-MM

ECU-3066-42-BF-KLR	1631	66/1676	48/1219	29/737	8/0.23	169/77
ECU-3072-42-BF-KLR	1692	72/1829	48/1219	29/737	9/0.25	175/79

For optional 3/4 modesty panel (18in / 455mm high) add suffix SM to product code. i.e. ECU-3072-42-BF-KLR-SM  
For optional 1/4 modesty panel (10in / 254mm high) add suffix MM to product code. i.e. ECU-3072-42-BF-KLR-MM

For additional specification instructions see page 6. Desk components can be found on page 123.  
Refer to pages 130-131 for electrical options and pages 132-133 for power/data, grommet placement options.  
See page 126 for keyboards and accessories.

**Spacesaver Extended Corner Unit Left- (ECU)**



Corner unit on left side, extension on right side, non connecting work surface with two side panels. Features Spacesaver cutout for keyboard. Wire grommet included.

\* Will not accommodate pedestal

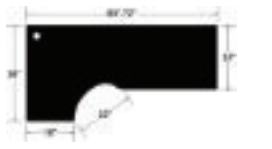

Corner unit on left side with narrow connecting side panel, ext, on right with full side panel. Links left to connecting 18" or 24" work surface. Features Spacesaver cutout for keyboard. Wire grommet included.

\* Will not accommodate pedestal

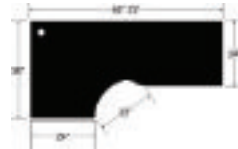

Corner unit on left side with extension on right side with narrow connecting side panel. Links right to connecting 18" or 24" work surface. Features Spacesaver cutout for keyboard. Wire grommet included.

\* Will not accommodate pedestal

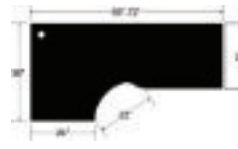

Corner unit on left side with ext. on right, each with narrow connecting side panel. Links right to 24" work surface and left to 18" or 24" work surface. Spacesaver cutout for keyboard. Wire grommet included.

\* Will not accommodate pedestal

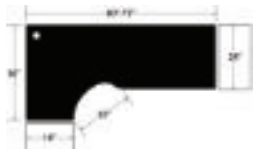

CODE	PRICE	WIDTH (in/mm)	DEPTH (in/mm)	HEIGHT (in/mm)	VOLUME (ft3/m3)	WEIGHT (lbs/kg)
------	-------	---------------	---------------	----------------	-----------------	-----------------

18"	ECU-1860-SLLF*	1072	60/1524	36/914	29/737	6/0.17	130/59
	ECU-1866-SLLF	1104	66/1676	36/914	29/737	7/0.20	136/62
	ECU-1872-SLLF	1138	72/1829	36/914	29/737	8/0.23	142/64
24"	ECU-2460-SLLF*	1072	60/1524	36/914	29/737	6/0.17	130/59
	ECU-2466-SLLF	1104	66/1676	36/914	29/737	7/0.20	136/62
	ECU-2472-SLLF	1138	72/1829	36/914	29/737	8/0.23	142/64

For optional 3/4 modesty panel (18in / 455mm high) add suffix SM to product code. i.e. ECU-1872-SLLF-SM

For optional 1/4 modesty panel (10in / 254mm high) add suffix MM to product code. i.e. ECU-1872-SLLF-MM

18"	ECU-1860-SLLL*	1072	60/1524	36/914	29/737	6/0.17	130/59
	ECU-1866-SLLL	1104	66/1676	36/914	29/737	7/0.20	136/62
	ECU-1872-SLLL	1138	72/1829	36/914	29/737	8/0.23	142/64
24"	ECU-2460-SLLL*	1072	60/1524	36/914	29/737	6/0.17	130/59
	ECU-2466-SLLL	1104	66/1676	36/914	29/737	7/0.20	136/62
	ECU-2472-SLLL	1138	72/1829	36/914	29/737	8/0.23	142/64

For optional 3/4 modesty panel (18in / 455mm high) add suffix SM to product code. i.e. ECU-1872-SLLL-SM

For optional 1/4 modesty panel (10in / 254mm high) add suffix MM to product code. i.e. ECU-1872-SLLL-MM

18"	ECU-1860-SLLR*	1072	60/1524	36/914	29/737	6/0.17	125/57
	ECU-1866-SLLR	1104	66/1676	36/914	29/737	7/0.20	130/59
	ECU-1872-SLLR	1138	72/1829	36/914	29/737	8/0.23	135/61
24"	ECU-2460-SLLR*	1072	60/1524	36/914	29/737	6/0.17	125/57
	ECU-2466-SLLR	1104	66/1676	36/914	29/737	7/0.20	130/59
	ECU-2472-SLLR	1138	72/1829	36/914	29/737	8/0.23	135/61

For optional 3/4 modesty panel (18in / 455mm high) add suffix SM to product code. i.e. ECU-1872-SLLR-SM

For optional 1/4 modesty panel (10in / 254mm high) add suffix MM to product code. i.e. ECU-1872-SLLR-MM

18"	ECU-1860-SLLC*	1072	60/1524	36/914	29/737	6/0.17	125/57
	ECU-1866-SLLC	1104	66/1676	36/914	29/737	7/0.20	130/59
	ECU-1872-SLLC	1138	72/1829	36/914	29/737	8/0.23	135/61
24"	ECU-2460-SLLC*	1072	60/1524	36/914	29/737	6/0.17	125/57
	ECU-2466-SLLC	1104	66/1676	36/914	29/737	7/0.20	130/59
	ECU-2472-SLLC	1138	72/1829	36/914	29/737	8/0.23	135/61

For optional 3/4 modesty panel (18in / 455mm high) add suffix SM to product code. i.e. ECU-1872-SLLC-SM

For optional 1/4 modesty panel (10in / 254mm high) add suffix MM to product code. i.e. ECU-1872-SLLC-MM

For additional specification instructions see page 6. Desk components can be found on page 123. Refer to pages 130-131 for electrical options and pages 132-133 for power/data, grommet placement options. See page 126 for keyboards and accessories. Divider panel sets and components available starting on page 102.



**Spacesaver Extended Corner Unit Right- (ECU)**



Corner unit on right side, extension on left side, non connecting work surface with two side panels. Features Spacesaver cutout for keyboard. Wire grommet included.

\* Will not accommodate pedestal

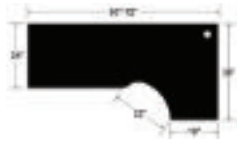

Corner unit on right side with narrow connecting side panel, ext. on left side with full side panel. Links left to 18" or 24" work surface. Features Spacesaver cutout for keyboard. Wire grommet included.

\* Will not accommodate pedestal



Corner unit on right side with extension on left side with narrow connecting side panel. Links right to connecting 18" or 24" work surface. Features Spacesaver cutout for keyboard. Wire grommet included.

\* Will not accommodate pedestal

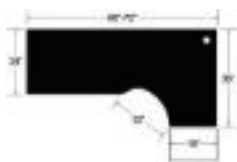

Corner unit on right side with ext. on left side, each with narrow connecting side panel. Links left to 24" work surface and right to 18" or 24" work surface. Spacesaver cutout for keyboard. Wire grommet included.

\* Will not accommodate pedestal

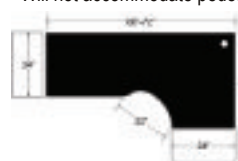
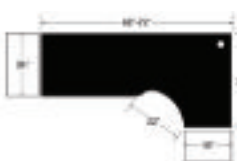

CODE	PRICE	WIDTH (in/mm)	DEPTH (in/mm)	HEIGHT (in/mm)	VOLUME (ft3/m3)	WEIGHT (lbs/kg)
------	-------	---------------	---------------	----------------	-----------------	-----------------

18"	ECU-1860-SRLF*	1072	60/1524	36/914	29/737	6/0.17	130/59
	ECU-1866-SRLF	1104	66/1676	36/914	29/737	7/0.20	136/62
	ECU-1872-SRLF	1138	72/1829	36/914	29/737	8/0.23	142/64
24"	ECU-2460-SRLF*	1072	60/1524	36/914	29/737	6/0.17	130/59
	ECU-2466-SRLF	1104	66/1676	36/914	29/737	7/0.20	136/62
	ECU-2472-SRLF	1138	72/1829	36/914	29/737	8/0.23	142/64

For optional 3/4 modesty panel (18in / 455mm high) add suffix SM to product code. i.e. ECU-1872-SRLF-SM  
For optional 1/4 modesty panel (10in / 254mm high) add suffix MM to product code. i.e. ECU-1872-SRLF-MM

18"	ECU-1860-SRLL*	1072	60/1524	36/914	29/737	6/0.17	130/59
	ECU-1866-SRLL	1104	66/1676	36/914	29/737	7/0.20	136/62
	ECU-1872-SRLL	1138	72/1829	36/914	29/737	8/0.23	142/64
24"	ECU-2460-SRLL*	1072	60/1524	36/914	29/737	6/0.17	130/59
	ECU-2466-SRLL	1104	66/1676	36/914	29/737	7/0.20	136/62
	ECU-2472-SRLL	1138	72/1829	36/914	29/737	8/0.23	142/64

For optional 3/4 modesty panel (18in / 455mm high) add suffix SM to product code. i.e. ECU-1872-SRLL-SM  
For optional 1/4 modesty panel (10in / 254mm high) add suffix MM to product code. i.e. ECU-1872-SRLL-MM

18"	ECU-1860-SRLR*	1072	60/1524	36/914	29/737	6/0.17	125/57
	ECU-1866-SRLR	1104	66/1676	36/914	29/737	7/0.20	130/59
	ECU-1872-SRLR	1138	72/1829	36/914	29/737	8/0.23	135/61
24"	ECU-2460-SRLR*	1072	60/1524	36/914	29/737	6/0.17	125/57
	ECU-2466-SRLR	1104	66/1676	36/914	29/737	7/0.20	130/59
	ECU-2472-SRLR	1138	72/1829	36/914	29/737	8/0.23	135/61

For optional 3/4 modesty panel (18in / 455mm high) add suffix SM to product code. i.e. ECU-1872-SRLR-SM  
For optional 1/4 modesty panel (10in / 254mm high) add suffix MM to product code. i.e. ECU-1872-SRLR-MM

18"	ECU-1860-SRLC*	1072	60/1524	36/914	29/737	6/0.17	125/57
	ECU-1866-SRLC	1104	66/1676	36/914	29/737	7/0.20	130/59
	ECU-1872-SRLC	1138	72/1829	36/914	29/737	8/0.23	135/61
24"	ECU-2460-SRLC*	1072	60/1524	36/914	29/737	6/0.17	125/57
	ECU-2466-SRLC	1104	66/1676	36/914	29/737	7/0.20	130/59
	ECU-2472-SRLC	1138	72/1829	36/914	29/737	8/0.23	135/61

For optional 3/4 modesty panel (18in / 455mm high) add suffix SM to product code. i.e. ECU-1872-SRLC-SM  
For optional 1/4 modesty panel (10in / 254mm high) add suffix MM to product code. i.e. ECU-1872-SRLC-MM

For additional specification instructions see page 6. Desk components can be found on page 123.  
Refer to pages 130-131 for electrical options and pages 132-133 for power/data, grommet placement options.  
See page 126 for keyboards and accessories. Divider panel sets and components available starting on page 102.





Open Hutch - 36"H

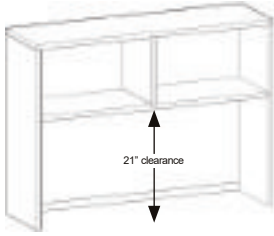

36"H Open Hutch with full width wire management. Optional hutch doors available. Center support dividers are provided with models 42" and wider.

CODE	PRICE	WIDTH (in/mm)	DEPTH (in/mm)	HEIGHT (in/mm)	VOLUME (ft3/m3)	WEIGHT (lbs/kg)
HUT-1424-36	472	24/610	14/356	36/914	3/0.08	66/30
HUT-1430-36	516	30/762	14/356	36/914	3/0.08	71/32
HUT-1436-36	565	36/914	14/356	36/914	3/0.08	78/35
HUT-1442-36	611	42/1067	14/356	36/914	4/0.11	84/38
HUT-1448-36	653	48/1219	14/356	36/914	4/0.11	91/41
HUT-1454-36	698	54/1372	14/356	36/914	4/0.11	97/44
HUT-1460-36	746	60/1524	14/356	36/914	5/0.14	104/47
HUT-1466-36	791	66/1676	14/356	36/914	5/0.14	110/50
HUT-1472-36	836	72/1829	14/356	36/914	6/0.17	116/53
HUT-1478-36	1004	78/1981	14/356	36/914	6/0.17	122/55

For optional grommet installed on back panel below shelf, add suffix "OG" to end of code i.e. HUT-1472-36-OG

Open Hutch with Organizer- 36"H

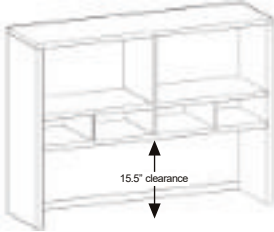

36"H Open Hutch with organizer, full width wire management. Optional hutch doors available. Center support dividers are provided with models 42" and wider.

HUT-1424-36-HS	661	24/610	14/356	36/914	3/0.08	73/33
HUT-1430-36-HS	708	30/762	14/356	36/914	3/0.08	78/35
HUT-1436-36-HS	751	36/914	14/356	36/914	3/0.08	86/39
HUT-1442-36-HS	815	42/1067	14/356	36/914	4/0.11	97/44
HUT-1448-36-HS	862	48/1219	14/356	36/914	4/0.11	109/49
HUT-1454-36-HS	923	54/1372	14/356	36/914	4/0.11	116/53
HUT-1460-36-HS	971	60/1524	14/356	36/914	5/0.14	125/57
HUT-1466-36-HS	1034	66/1676	14/356	36/914	5/0.14	138/63
HUT-1472-36-HS	1078	72/1829	14/356	36/914	6/0.17	145/66
HUT-1478-36-HS	1292	78/1981	14/356	36/914	6/0.17	153/69

For optional grommet installed on back panel below shelf, add suffix "OG" to end of code i.e. HUT-1472-36-HS-OG

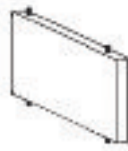

DIV-14-HS	49	Extra divider with pins				
-----------	----	-------------------------	--	--	--	--

Corner Hutch - 36"H

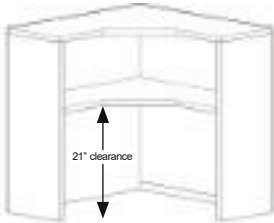

36"H Open Corner Hutch with full width wire management. Optional hutch doors available.

HUT-3636-36	978	36/914	36/914	36/914	4/0.11	145/66
HUT-4242-36	1036	42/1067	42/1067	36/914	4/0.11	170/77
HUT-4848-36	1090	48/1219	48/1219	36/914	4/0.11	180/82

See pages 66 & 67 for optional hutch door kits and page 70 for tackboard options. For additional specification instructions see page 6.

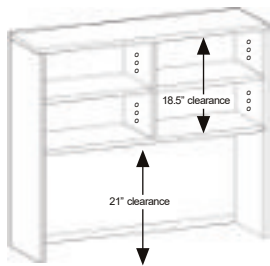

42"H Open Hutch with full width wire management. Optional hutch doors available. Center support dividers are provided with models 42" and wider.

CODE	PRICE	WIDTH (in/mm)	DEPTH (in/mm)	HEIGHT (in/mm)	VOLUME (ft <sup>3</sup> /m <sup>3</sup> )	WEIGHT (lbs/kg)
HUT-1424-42	613	24/610	14/356	42/1067	4/0.11	86/39
HUT-1430-42	672	30/762	14/356	42/1067	4/0.11	92/42
HUT-1436-42	736	36/914	14/356	42/1067	4/0.11	101/46
HUT-1442-42	791	42/1067	14/356	42/1067	5/0.14	109/49
HUT-1448-42	850	48/1219	14/356	42/1067	5/0.14	118/54
HUT-1454-42	910	54/1372	14/356	42/1067	5/0.14	126/57
HUT-1460-42	971	60/1524	14/356	42/1067	6/0.17	135/61
HUT-1466-42	1032	66/1676	14/356	42/1067	6/0.17	143/65
HUT-1472-42	1088	72/1829	14/356	42/1067	7/0.20	151/68
HUT-1478-42	1307	78/1981	14/356	42/1067	7/0.20	159/72

For optional grommet installed on back panel below shelf, add suffix "OG" to end of code i.e. HUT-1472-42-OG

Open Hutch with Organizer- 42"H Added Storage

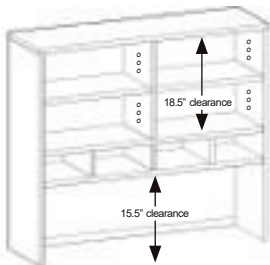

42"H Open Hutch with organizer, full width wire management. Optional hutch doors available. Center support dividers are provided with models 42" and wider.

HUT-1424-42-HS	803	24/610	14/356	42/1067	4/0.11	95/43
HUT-1430-42-HS	863	30/762	14/356	42/1067	4/0.11	101/46
HUT-1436-42-HS	923	36/914	14/356	42/1067	4/0.11	116/53
HUT-1442-42-HS	998	42/1067	14/356	42/1067	5/0.14	125/57
HUT-1448-42-HS	1058	48/1219	14/356	42/1067	5/0.14	136/62
HUT-1454-42-HS	1130	54/1372	14/356	42/1067	5/0.14	151/68
HUT-1460-42-HS	1195	60/1524	14/356	42/1067	6/0.17	162/73
HUT-1466-42-HS	1270	66/1676	14/356	42/1067	6/0.17	172/78
HUT-1472-42-HS	1328	72/1829	14/356	42/1067	7/0.20	189/86
HUT-1478-42-HS	1594	78/1981	14/356	42/1067	7/0.20	207/94

For optional grommet installed on back panel below shelf, add suffix "OG" to end of code i.e. HUT-1472-42-HS-OG

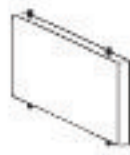

DIV-14-HS	49	Extra divider with pins				
-----------	----	-------------------------	--	--	--	--

Corner Hutch - 42"H Added Storage

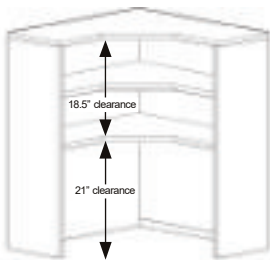

42"H Open Corner Hutch with full width wire management. Optional hutch doors available.

HUT-3636-42	1272	36/914	36/914	42/1067	5/0.14	189/86
HUT-4242-42	1343	42/1067	42/1067	42/1067	5/0.14	221/100
HUT-4848-42	1417	48/1219	48/1219	42/1067	5/0.14	234/106

See pages 68 & 69 for optional hutch door kits and page 70 for tackboard options. For additional specification instructions see page 6.

**Open Hutch - 42”H Standard Divider**

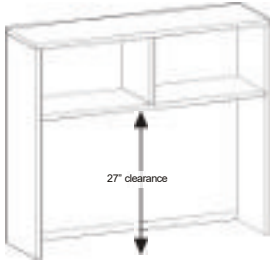

42”H Open Hutch with full width wire management. Optional hutch doors available. Center support dividers are provided with models 42” and wider.

CODE	PRICE	WIDTH (in/mm)	DEPTH (in/mm)	HEIGHT (in/mm)	VOLUME (ft3/m3)	WEIGHT (lbs/kg)
HUT-1424-42-SD	613	24/610	14/356	42/1067	4/0.11	86/39
HUT-1430-42-SD	672	30/762	14/356	42/1067	4/0.11	92/42
HUT-1436-42-SD	736	36/914	14/356	42/1067	4/0.11	101/46
HUT-1442-42-SD	791	42/1067	14/356	42/1067	5/0.14	109/49
HUT-1448-42-SD	850	48/1219	14/356	42/1067	5/0.14	118/54
HUT-1454-42-SD	910	54/1372	14/356	42/1067	5/0.14	126/57
HUT-1460-42-SD	971	60/1524	14/356	42/1067	6/0.17	135/61
HUT-1466-42-SD	1032	66/1676	14/356	42/1067	6/0.17	143/65
HUT-1472-42-SD	1088	72/1829	14/356	42/1067	7/0.20	151/68
HUT-1478-42-SD	1307	78/1981	14/356	42/1067	7/0.20	159/72

For optional grommet installed on back panel below shelf, add suffix "OG" to end of code i.e. HUT-1472-42-SD-OG

**Open Hutch w/ Organizer- 42”H Standard Divider**

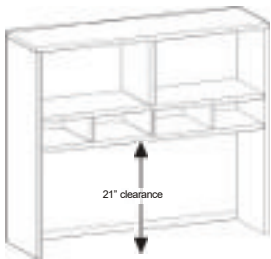

42”H Open Hutch with organizer, full width wire management. Optional hutch doors available. Center support dividers are provided with models 42” and wider.

HUT-1424-42-HS-SD	803	24/610	14/356	42/1067	4/0.11	95/43
HUT-1430-42-HS-SD	863	30/762	14/356	42/1067	4/0.11	101/46
HUT-1436-42-HS-SD	923	36/914	14/356	42/1067	4/0.11	116/53
HUT-1442-42-HS-SD	998	42/1067	14/356	42/1067	5/0.14	125/57
HUT-1448-42-HS-SD	1058	48/1219	14/356	42/1067	5/0.14	136/62
HUT-1454-42-HS-SD	1130	54/1372	14/356	42/1067	5/0.14	151/68
HUT-1460-42-HS-SD	1195	60/1524	14/356	42/1067	6/0.17	162/73
HUT-1466-42-HS-SD	1270	66/1676	14/356	42/1067	6/0.17	172/78
HUT-1472-42-HS-SD	1328	72/1829	14/356	42/1067	7/0.20	189/86
HUT-1478-42-HS-SD	1594	78/1981	14/356	42/1067	7/0.20	207/94

For optional grommet installed on back panel below shelf, add suffix "OG" to end of code i.e. HUT-1472-42-HS-SD-OG



DIV-14-HS	49	Extra divider with pins				
-----------	----	-------------------------	--	--	--	--

**Corner Hutch - 42”H w/ Standard Divider**

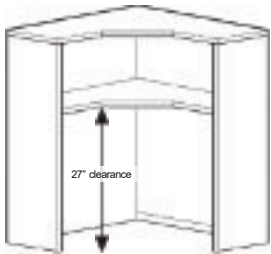

42”H Open Corner Hutch with full width wire management. Optional hutch doors available.

HUT-3636-42-SD	1272	36/914	36/914	42/1067	5/0.14	189/86
HUT-4242-42-SD	1343	42/1067	42/1067	42/1067	5/0.14	221/100
HUT-4848-42-SD	1417	48/1219	48/1219	42/1067	5/0.14	234/106

See pages 66 & 67 for optional hutch door kits and page 70 for tackboard options. For additional specification instructions see page 6.

**Open Hutch - 50”H Double Storage**

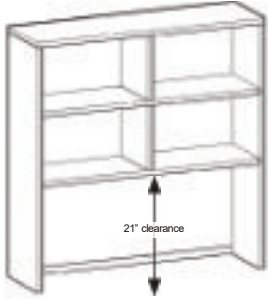

50”H Open hutch with full wire management. Optional hutch doors available. Center support dividers are provided with models 42” and wider.

CODE	PRICE	WIDTH (in/mm)	DEPTH (in/mm)	HEIGHT (in/mm)	VOLUME (ft <sup>3</sup> /m <sup>3</sup> )	WEIGHT (lbs/kg)
------	-------	------------------	------------------	-------------------	--	--------------------

HUT-1424-50	708	24/610	14/356	50/1270	5/0.14	99/45
HUT-1430-50	778	30/762	14/356	50/1270	5/0.14	107/49
HUT-1436-50	847	36/914	14/356	50/1270	5/0.14	117/53
HUT-1442-50	914	42/1067	14/356	50/1270	6/0.17	126/57
HUT-1448-50	982	48/1219	14/356	50/1270	6/0.17	137/62
HUT-1454-50	1046	54/1372	14/356	50/1270	6/0.17	146/66
HUT-1460-50	1121	60/1524	14/356	50/1270	7/0.20	156/71
HUT-1466-50	1187	66/1676	14/356	50/1270	7/0.20	165/75
HUT-1472-50	1255	72/1829	14/356	50/1270	8/0.23	174/79
HUT-1478-50	1506	78/1981	14/356	50/1270	8/0.23	183/83

For optional grommet installed on back panel below shelf, add suffix "OG" to end of code i.e. HUT-1472-50-OG

**Open Hutch with Storage - 50”H Double Storage**

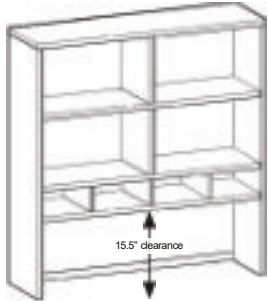

50”H Open hutch with organizer, full wire management. Optional hutch doors available. Center support dividers are provided with models 42” and wider.

HUT-1424-50-HS	898	24/610	14/356	50/1270	5/0.14	108/49
HUT-1430-50-HS	968	30/762	14/356	50/1270	5/0.14	116/53
HUT-1436-50-HS	1036	36/914	14/356	50/1270	5/0.14	132/60
HUT-1442-50-HS	1121	42/1067	14/356	50/1270	6/0.17	142/64
HUT-1448-50-HS	1189	48/1219	14/356	50/1270	6/0.17	155/70
HUT-1454-50-HS	1271	54/1372	14/356	50/1270	6/0.17	171/78
HUT-1460-50-HS	1344	60/1524	14/356	50/1270	7/0.20	183/83
HUT-1466-50-HS	1427	66/1676	14/356	50/1270	7/0.20	194/88
HUT-1472-50-HS	1495	72/1829	14/356	50/1270	8/0.23	212/96
HUT-1478-50-HS	1794	78/1981	14/356	50/1270	8/0.23	231/105

For optional grommet installed on back panel below shelf, add suffix "OG" to end of code i.e. HUT-1472-50-HS-OG



DIV-14-HS	49	Extra divider with pins				
-----------	----	-------------------------	--	--	--	--

See pages 68 & 69 for optional hutch door kits and page 70 for tackboard options. For additional specification instructions see page 6.



Optional Addition to freestanding hutch

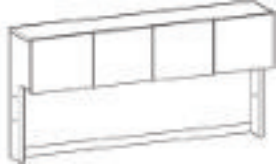

Center Hutch with two recessed connecting gables left and right side. Add "LC" to end of code. Ex. HUT-1472-36-LC.

Fits all freestanding hutches.

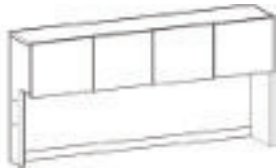

Left recessed Hutch with one connecting gable on left side and one whole gable on right side. Add "LL" to end of code. Ex. HUT-1472-36-LL.

Fits all freestanding hutches.

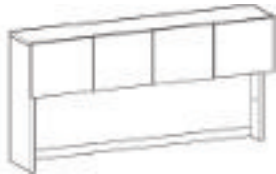

Right recessed Hutch with one connecting gable on right side and one whole gable on left side. Add "LR" to end of code. Ex. HUT-1472-36-LR.

Fits all freestanding hutches.

Hutch Paper Manager



Hutch Paper Manager (PM) with three adjustable shelves. Fits into 15" open space.



Hutch Paper Manager (PM) with four adjustable shelves. Fits into 21" open space.



Hutch Paper Manager (PM) with five adjustable shelves. Fits into 27" open space.

CODE	PRICE	WIDTH (in/mm)	DEPTH (in/mm)	HEIGHT (in/mm)	VOLUME (ft3/m3)	WEIGHT (lbs/kg)
------	-------	------------------	------------------	-------------------	--------------------	--------------------

LC	184	Center Hutch - add				
----	-----	--------------------	--	--	--	--

\*Whole gables are required at the ends of each row of connected hutches\*

LL	92	Left Recessed Hutch - add				
----	----	---------------------------	--	--	--	--

\*Whole gables are required at the ends of each row of connected hutches\*

LR	92	Right Recessed Hutch - add				
----	----	----------------------------	--	--	--	--

\*Whole gables are required at the ends of each row of connected hutches\*

HUT-1316-15-PM	487	16/406	13/330	15/381	2.0/0.06	20/9
----------------	-----	--------	--------	--------	----------	------

HUT-1316-21-PM	536	16/406	13/330	21/533	2.5/0.07	23/10
----------------	-----	--------	--------	--------	----------	-------

HUT-1316-27-PM	617	16/406	13/330	27/686	3.0/0.08	30/14
----------------	-----	--------	--------	--------	----------	-------

For additional specification instructions see page 6.



Wall Mounted Open Hutch - 14"H



Wall mounted hutch. Convenient overhead storage. Optional door kits available.



CODE	PRICE	WIDTH (in/mm)	DEPTH (in/mm)	HEIGHT (in/mm)	VOLUME (ft3/m3)	WEIGHT (lbs/kg)
WMHT-1424-14	499	24/610	14/356	14/356	3/0.08	26/12
WMHT-1430-14	548	30/762	14/356	14/356	3/0.08	31/14
WMHT-1436-14	590	36/914	14/356	14/356	3/0.08	38/17
WMHT-1442-14	637	42/1067	14/356	14/356	4/0.11	44/20
WMHT-1448-14	679	48/1219	14/356	14/356	4/0.11	51/23
WMHT-1454-14	726	54/1372	14/356	14/356	4/0.11	57/26
WMHT-1460-14	775	60/1524	14/356	14/356	5/0.14	64/29
WMHT-1466-14	818	66/1676	14/356	14/356	5/0.14	70/32
WMHT-1472-14	863	72/1829	14/356	14/356	6/0.17	76/34

Wall Mounted Open Hutch w/ Organizer - 20"H



Wall mounted hutch with organizer shelf. Convenient overhead storage. Optional door kits available.



WMHT-1424-20-HS	690	24/610	14/356	20/508	3/0.08	36/16
WMHT-1430-20-HS	738	30/762	14/356	20/508	3/0.08	41/19
WMHT-1436-20-HS	781	36/914	14/356	20/508	3/0.08	48/22
WMHT-1442-20-HS	844	42/1067	14/356	20/508	4/0.11	54/24
WMHT-1448-20-HS	887	48/1219	14/356	20/508	4/0.11	61/28
WMHT-1454-20-HS	952	54/1372	14/356	20/508	4/0.11	67/30
WMHT-1460-20-HS	998	60/1524	14/356	20/508	5/0.14	74/34
WMHT-1466-20-HS	1060	66/1676	14/356	20/508	5/0.14	80/36
WMHT-1472-20-HS	1103	72/1829	14/356	20/508	6/0.17	86/39



DIV-14-HS	49	Extra divider with pins				
-----------	----	-------------------------	--	--	--	--

WALL MOUNTED STORAGE CABINET INSTALLATION HARDWARE

All wall mounted storage cabinets are shipped with Z-Bar attachment assembly. The Z-Bar assembly is a simple two bracket attachment used for all wall mounted storage cabinets. The Z-Bar is mounted to the full length of wall and includes pre-punched holes.

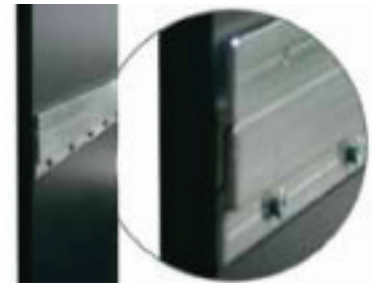

See pages 66 & 67 for optional hutch door kits.  
For additional specification instructions see page 6.



Open Hutch - 38"H

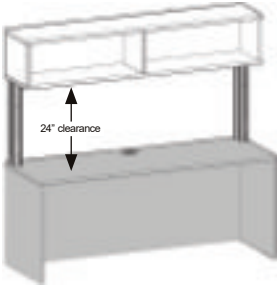

Post mounted hutch. Includes four 24" high posts and mounting hardware. Optional hutch door kits available. Refer to Links panel inserts for optional back panel(s).

Corner Hutch - 38"H

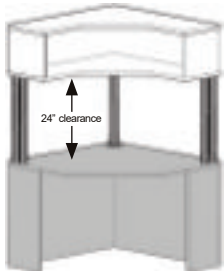

Post mounted hutch. Includes five 24" high posts and mounting hardware. Optional hutch door kits available. Refer to Links panel inserts for optional back panel(s).

Open Hutch with Organizer - 38"H

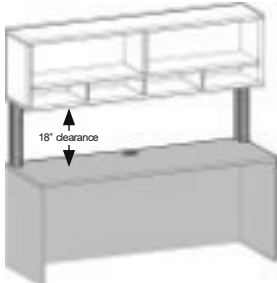

Post mounted hutch. Includes four 18" high posts and mounting hardware. Optional hutch door kits available. Refer to Links panel inserts for optional back panel(s).



Corner Hutch with Organizer - 38"H

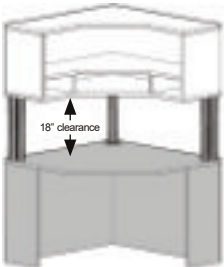

Post mounted hutch. Includes five 18" high posts and mounting hardware. Optional hutch door kits available. Refer to Links panel inserts for optional back panel(s).

CODE	PRICE	WIDTH (in/mm)	DEPTH (in/mm)	HEIGHT (in/mm)	VOLUME (ft3/m3)	WEIGHT (lbs/kg)
------	-------	------------------	------------------	-------------------	--------------------	--------------------

PMHT-1424-38	661	24/610	14/356	38/965	3/0.08	46/21
PMHT-1430-38	709	30/762	14/356	38/965	3/0.08	51/23
PMHT-1436-38	751	36/914	14/356	38/965	3/0.08	58/26
PMHT-1442-38	800	42/1067	14/356	38/965	4/0.11	64/29
PMHT-1448-38	844	48/1219	14/356	38/965	4/0.11	71/32
PMHT-1454-38	889	54/1372	14/356	38/965	4/0.11	77/35
PMHT-1460-38	936	60/1524	14/356	38/965	5/0.14	84/38
PMHT-1466-38	980	66/1676	14/356	38/965	5/0.14	90/41
PMHT-1472-38	1026	72/1829	14/356	38/965	6/0.17	96/44

PMHT-3636-CU-38	1169	36/914	36/914	38/965	4/0.11	120/54
PMHT-4242-CU-38	1225	42/1067	42/1067	38/965	4/0.11	130/59
PMHT-4848-CU-38	1279	48/1219	48/1219	38/965	4/0.11	140/64

PMHT-1424-38-HS	850	24/610	14/356	38/965	4/0.11	53/24
PMHT-1430-38-HS	899	30/762	14/356	38/965	4/0.11	58/26
PMHT-1436-38-HS	942	36/914	14/356	38/965	4/0.11	66/30
PMHT-1442-38-HS	989	42/1067	14/356	38/965	5/0.14	77/35
PMHT-1448-38-HS	1039	48/1219	14/356	38/965	5/0.14	89/40
PMHT-1454-38-HS	1115	54/1372	14/356	38/965	5/0.14	96/44
PMHT-1460-38-HS	1160	60/1524	14/356	38/965	6/0.17	105/48
PMHT-1466-38-HS	1223	66/1676	14/356	38/965	6/0.17	118/54
PMHT-1472-38-HS	1278	72/1829	14/356	38/965	7/0.20	125/57

DIV-14-HS	49	Extra divider with pins				
-----------	----	-------------------------	--	--	--	--

PMHT-3636-CU-38-HS	1405	36/914	36/914	38/965	5/0.14	149/68
PMHT-4242-CU-38-HS	1466	42/1067	42/1067	38/965	5/0.14	163/74
PMHT-4848-CU-38-HS	1530	48/1219	48/1219	38/965	5/0.14	175/79

See pages 66 & 67 for optional hutch door kits.  
Optional panel inserts and components available starting on page 103.  
For additional specification instructions see page 6.



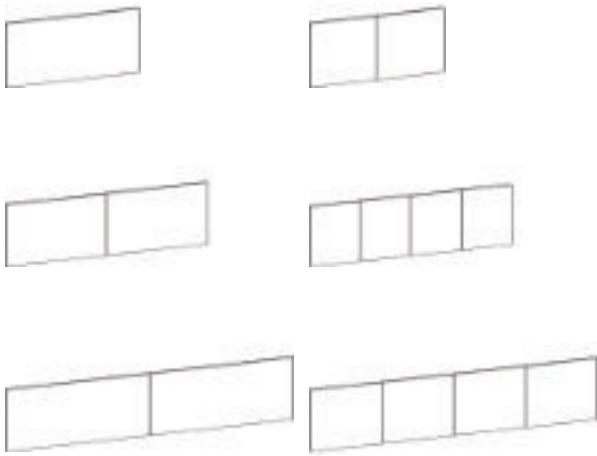

2 flip-up door for 54"W-78"W hutch    4 hinged doors for 54"W-78"W hutch

CODE	PRICE	WIDTH (in/mm)	DEPTH (in/mm)	HEIGHT (in/mm)	VOLUME (ft3/m3)	WEIGHT (lbs/kg)
DKT-24	220	24/610	0.75/19	14/356	1/0.03	8/4
DKT-24-HING	220	24/610	0.75/19	14/356	5/0.14	8/4
DKT-30	220	30/762	0.75/19	14/356	1/0.03	10/5
DKT-30-HING	220	30/762	0.75/19	14/356	6/0.17	10/5
DKT-36	220	36/914	0.75/19	14/356	1/0.03	13/6
DKT-36-HING	220	36/914	0.75/19	14/356	8/0.23	13/6
DKT-42	300	42/1067	0.75/19	14/356	1/0.03	15/7
DKT-42-HING	300	42/1067	0.75/19	14/356	9/0.25	15/7
DKT-48	300	48/1219	0.75/19	14/356	1/0.03	17/8
DKT-48-HING	300	48/1219	0.75/19	14/356	11/0.31	17/8
DKT-54	317	54/1372	0.75/19	14/356	1/0.03	19/9
DKT-54-HING	317	54/1372	0.75/19	14/356	13/0.37	19/9
DKT-60	317	60/1524	0.75/19	14/356	1/0.03	21/10
DKT-60-HING	317	60/1524	0.75/19	14/356	15/0.42	21/10
DKT-66	317	66/1676	0.75/19	14/356	1/0.03	23/10
DKT-66-HING	317	66/1676	0.75/19	14/356	16/0.45	23/10
DKT-72	317	72/1829	0.75/19	14/356	1/0.03	26/12
DKT-72-HING	317	72/1829	0.75/19	14/356	18/0.51	26/12
DKT-78	397	78/1981	0.75/19	14/356	1/0.03	28/13
DKT-78-HING	397	78/1981	0.75/19	14/356	19/0.54	28/13

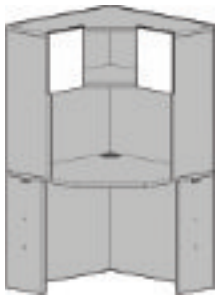

Two flip-up or two hinged doors for 36", 42" or 48" corner hutches

Center section remains open.  
Includes two divider panels

DKT-3636-CH	385	36/914	0.75/19	14/356	1/0.03	13/6
DKT-3636-HING	385	36/914	0.75/19	14/356	1/0.03	13/6
DKT-4242-CH	395	42/1067	0.75/19	14/356	1/0.03	15/7
DKT-4242-HING	395	42/1067	0.75/19	14/356	1/0.03	15/7
DKT-4848-CH	401	48/1219	0.75/19	14/356	1/0.03	18/8
DKT-4848-HING	401	48/1219	0.75/19	14/356	1/0.03	18/8

Optional Locks



Optional Hutch Lock for hutch door(s). Factory installed.

1LK	117	(Flip-up Style) Hutch 24-36in wide (Hinged Style) Hutch 24-36in wide
2LK	234	(Flip-up Style) Hutch 42in and wider (Hinged Style) Hutch 42in and wider

Optional Handles

For two hinged doors.  
For four hinged doors.

2P	56	Hutch 24-36in wide
4P	112	Hutch 42in and wider

For additional specification instructions and handle options see pages 6-7.

CODE	PRICE	WIDTH (in/mm)	DEPTH (in/mm)	HEIGHT (in/mm)	VOLUME (ft3/m3)	WEIGHT (lbs/kg)
------	-------	------------------	------------------	-------------------	--------------------	--------------------

Glazed Door Kits for freestanding 36”H, postmounted 38”H hutches, & 42”H standard divider hutches

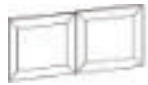

2 glazed hinged doors for 24”W-36”W hutch

DKT-24-HING- <b>Z</b>	590	24/610	0.75/19	14/356	5/0.14	8/4
DKT-30-HING- <b>Z</b>	590	30/762	0.75/19	14/356	6/0.17	10/5
DKT-36-HING- <b>Z</b>	590	36/914	0.75/19	14/356	8/0.23	13/6
DKT-42-HING- <b>Z</b>	871	42/1067	0.75/19	14/356	9/0.25	15/7
DKT-48-HING- <b>Z</b>	871	48/1219	0.75/19	14/356	11/0.31	17/8
DKT-54-HING- <b>Z</b>	1080	54/1372	0.75/19	14/356	13/0.37	19/9
DKT-60-HING- <b>Z</b>	1080	60/1524	0.75/19	14/356	15/0.42	21/10
DKT-66-HING- <b>Z</b>	1080	66/1676	0.75/19	14/356	16/0.45	23/10
DKT-72-HING- <b>Z</b>	1080	72/1829	0.75/19	14/356	18/0.51	26/12
DKT-78-HING- <b>Z</b>	1296	78/1981	0.75/19	14/356	19/0.54	28/13



4 glazed hinged doors for 42”W to 78”W hutch

**Z** - Specify door frame colour  
**SZ** = Silver frame  
**BZ** = Black frame  
**WZ** = White frame

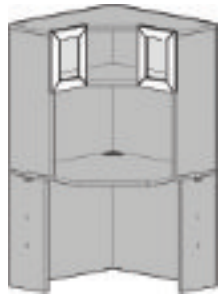

Two glazed hinged doors for 36” 42” or 48” corner hutch. Center section remains open. Includes two divider panels.

DKT-3636-HING- <b>Z</b>	725	36/914	0.75/19	14/356	1/0.03	13/6
DKT-4242-HING- <b>Z</b>	737	42/1067	0.75/19	14/356	1/0.03	15/7
DKT-4848-HING- <b>Z</b>	744	48/1219	0.75/19	14/356	1/0.03	18/8

**Z** - Specify door frame colour  
**SZ** = Silver frame  
**BZ** = Black frame  
**WZ** = White frame

Optional Locks



Optional Hutch Lock for hutch door(s). Factory installed.

1LK	117	Hutch 24-36in wide
2LK	234	Hutch 42in and wider

Optional Handles

For two hinged doors.  
 For four hinged doors.

2P	56	Hutch 24-36in wide
4P	112	Hutch 42in and wider

For additional specification instructions and handle options see pages 6-7.

Laminate Door Kits for freestanding 42”H hutches



2 hinged doors for 24”W to 36”W hutch.

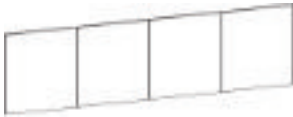

4 hinged doors for 42”W to 78”W hutch.

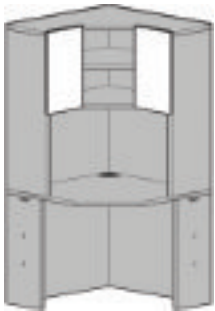

Two hinged doors for 36”, 42” or 48” corner hutch. Center section remains open. Includes two divider panels.

CODE	PRICE	WIDTH (in/mm)	DEPTH (in/mm)	HEIGHT (in/mm)	VOLUME (ft3/m3)	WEIGHT (lbs/kg)
DKT-24-HING-DBL	358	24/610	0.75/19	20/508	5/0.14	12/5
DKT-30-HING-DBL	358	30/762	0.75/19	20/508	7/0.20	15/7
DKT-36-HING-DBL	358	36/914	0.75/19	20/508	9/0.25	18/8
DKT-42-HING-DBL	511	42/1067	0.75/19	20/508	10/0.28	21/10
DKT-48-HING-DBL	511	48/1219	0.75/19	20/508	12/0.34	24/11
DKT-54-HING-DBL	581	54/1372	0.75/19	20/508	14/0.40	27/12
DKT-60-HING-DBL	581	60/1524	0.75/19	20/508	16/0.45	30/14
DKT-66-HING-DBL	581	66/1676	0.75/19	20/508	18/0.51	32/15
DKT-72-HING-DBL	581	72/1829	0.75/19	20/508	20/0.57	35/16
DKT-78-HING-DBL	698	78/1981	0.75/19	20/508	22/0.62	38/17

DKT-3636-HING-DBL	551	36/914	0.75/19	20/508	1/0.03	18/8
DKT-4242-HING-DBL	564	42/1067	0.75/19	20/508	1/0.03	21/10
DKT-4848-HING-DBL	576	48/1219	0.75/19	20/508	2/0.06	24/11

Laminate Door Kits for freestanding 50”H hutches

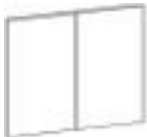

2 hinged doors for 24”W to 36”W hutch.

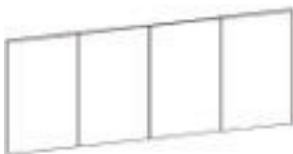

4 hinged doors for 42”W to 78”W hutch.

DKT-24-HING-DBS	439	24/610	0.75/19	28/711	7/0.20	15/7
DKT-30-HING-DBS	439	30/762	0.75/19	28/711	9/0.25	18/8
DKT-36-HING-DBS	439	36/914	0.75/19	28/711	11/0.31	21/10
DKT-42-HING-DBS	599	42/1067	0.75/19	28/711	12/0.34	27/12
DKT-48-HING-DBS	599	48/1219	0.75/19	28/711	14/0.40	30/14
DKT-54-HING-DBS	635	54/1372	0.75/19	28/711	16/0.45	33/15
DKT-60-HING-DBS	635	60/1524	0.75/19	28/711	19/0.54	36/16
DKT-66-HING-DBS	635	66/1676	0.75/19	28/711	21/0.59	39/18
DKT-72-HING-DBS	635	72/1829	0.75/19	28/711	24/0.68	43/20
DKT-78-HING-DBS	796	78/1981	0.75/19	28/711	28/0.79	48/22

Optional Locks



Optional Hutch Lock for hutch door(s). Factory installed.

1LK	117	Hutch 24-36in wide
2LK	234	Hutch 42in and wider

Optional Handles

For two hinged doors.  
For four hinged doors.

2P	56	Hutch 24-36in wide
4P	112	Hutch 42in and wider

For additional specification instructions see pages 6-7.

Glazed Door Kits for freestanding 42”H hutches

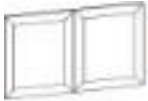

2 glazed hinged doors for 24”W to 36”W hutch.

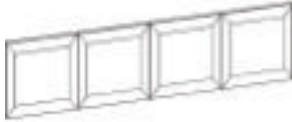

4 glazed hinged doors for 42”W to 78”W hutch.

**Z** - Specify door frame colour  
**SZ** = Silver frame  
**BZ** = Black frame  
**WZ** = White frame

CODE	PRICE	WIDTH (in/mm)	DEPTH (in/mm)	HEIGHT (in/mm)	VOLUME (ft3/m3)	WEIGHT (lbs/kg)
DKT-24-HING-DBL- <b>Z</b>	700	24/610	0.75/19	20/508	5/0.14	12/5
DKT-30-HING-DBL- <b>Z</b>	700	30/762	0.75/19	20/508	7/0.20	15/7
DKT-36-HING-DBL- <b>Z</b>	700	36/914	0.75/19	20/508	9/0.25	18/8
DKT-42-HING-DBL- <b>Z</b>	1021	42/1067	0.75/19	20/508	10/0.28	21/10
DKT-48-HING-DBL- <b>Z</b>	1021	48/1219	0.75/19	20/508	12/0.34	24/11
DKT-54-HING-DBL- <b>Z</b>	1264	54/1372	0.75/19	20/508	14/0.40	27/12
DKT-60-HING-DBL- <b>Z</b>	1264	60/1524	0.75/19	20/508	16/0.45	30/14
DKT-66-HING-DBL- <b>Z</b>	1264	66/1676	0.75/19	20/508	18/0.51	32/15
DKT-72-HING-DBL- <b>Z</b>	1264	72/1829	0.75/19	20/508	20/0.57	35/16
DKT-78-HING-DBL- <b>Z</b>	1517	78/1981	0.75/19	20/508	22/0.62	38/17



Two glazed hinged doors for 36”, 42” or 48” corner hutch. Center section remains open. Includes two divider panels.

**Z** - Specify door frame colour  
**SZ** = Silver frame  
**BZ** = Black frame  
**WZ** = White frame

DKT-3636-HING-DBL- <b>Z</b>	890	36/914	0.75/19	20/508	1/0.03	18/8
DKT-4242-HING-DBL- <b>Z</b>	904	42/1067	0.75/19	20/508	1/0.03	21/10
DKT-4848-HING-DBL- <b>Z</b>	916	48/1219	0.75/19	20/508	2/0.06	24/11

Glazed Door Kits for freestanding 50”H hutches



2 glazed hinged doors for 24”W to 36”W hutch.



4 glazed hinged doors for 42”W to 78”W hutch.

**Z** - Specify door frame colour  
**SZ** = Silver frame  
**BZ** = Black frame  
**WZ** = White frame

DKT-24-HING-DBS- <b>Z</b>	1182	24/610	0.75/19	28/711	7/0.20	15/7
DKT-30-HING-DBS- <b>Z</b>	1182	30/762	0.75/19	28/711	9/0.25	18/8
DKT-36-HING-DBS- <b>Z</b>	1182	36/914	0.75/19	28/711	11/0.31	21/10
DKT-42-HING-DBS- <b>Z</b>	1740	42/1067	0.75/19	28/711	12/0.34	27/12
DKT-48-HING-DBS- <b>Z</b>	1740	48/1219	0.75/19	28/711	14/0.40	30/14
DKT-54-HING-DBS- <b>Z</b>	2159	54/1372	0.75/19	28/711	16/0.45	33/15
DKT-60-HING-DBS- <b>Z</b>	2159	60/1524	0.75/19	28/711	19/0.54	36/16
DKT-66-HING-DBS- <b>Z</b>	2159	66/1676	0.75/19	28/711	21/0.59	39/18
DKT-72-HING-DBS- <b>Z</b>	2159	72/1829	0.75/19	28/711	24/0.68	43/20
DKT-78-HING-DBS- <b>Z</b>	2591	78/1981	0.75/19	28/711	28/0.79	48/22

Optional Locks



Optional Hutch Lock for hutch door(s). Factory installed.

1LK	117	Hutch 24-36in wide
2LK	234	Hutch 42in and wider

Optional Handles

For two hinged doors.  
 For four hinged doors.

2P	56	Hutch 24-36in wide
4P	112	Hutch 42in and wider

For additional specification instructions see pages 6-7.

tack boards - 36/42/50in high hutches w/ organizer



For use with 36"H, 42"H and 50"H hutches with organizer that have a 15.5" clearance.

CODE	PRICE	WIDTH (in/mm)	DEPTH (in/mm)	HEIGHT (in/mm)	VOLUME (ft3/m3)	WEIGHT (lbs/kg)
TB-2413	305	22/559	0.75/19	13/330	0.4/0.01	5/2
TB-3013	316	28/711	0.75/19	13/330	0.5/0.01	5/2
TB-3613	323	34/864	0.75/19	13/330	0.6/0.02	5/2
TB-4213	336	40/1016	0.75/19	13/330	0.7/0.02	6/3
TB-4813	344	46/1168	0.75/19	13/330	0.8/0.02	6/3
TB-5413	353	52/1321	0.75/19	13/330	0.9/0.03	6/3
TB-6013	364	58/1473	0.75/19	13/330	1.0/0.03	7/3
TB-6613	372	64/1626	0.75/19	13/330	1.0/0.03	7/3
TB-7213	382	70/1778	0.75/19	13/330	1.1/0.03	7/3
TB-7813	457	76/1930	0.75/19	13/330	1.5/0.04	8/4

tack boards - 36/42/50in high hutches



For use with 36"H, 42"H and 50"H hutches that have a 21" clearance.

TB-2419	323	22/559	0.75/19	19/483	0.6/0.02	5/2
TB-3019	332	28/711	0.75/19	19/483	0.7/0.02	5/2
TB-3619	342	34/864	0.75/19	19/483	0.8/0.02	5/2
TB-4219	352	40/1016	0.75/19	19/483	0.9/0.03	6/3
TB-4819	362	46/1168	0.75/19	19/483	1.0/0.03	6/3
TB-5419	370	52/1321	0.75/19	19/483	1.2/0.03	6/3
TB-6019	380	58/1473	0.75/19	19/483	1.4/0.04	7/3
TB-6619	390	64/1626	0.75/19	19/483	1.5/0.04	7/3
TB-7219	398	70/1778	0.75/19	19/483	1.6/0.05	7/3
TB-7819	479	76/1930	0.75/19	19/483	1.8/0.05	8/4

tack boards - 42in high standard divider hutches



For use with 42"H hutches that have a standard divider and 27" clearance.

TB-2425	355	22/559	0.75/19	25/635	0.6/0.02	5/2
TB-3025	366	28/711	0.75/19	25/635	0.7/0.02	5/2
TB-3625	376	34/864	0.75/19	25/635	0.8/0.02	5/2
TB-4225	388	40/1016	0.75/19	25/635	0.9/0.03	6/3
TB-4825	397	46/1168	0.75/19	25/635	1.0/0.03	6/3
TB-5425	407	52/1321	0.75/19	25/635	1.2/0.03	6/3
TB-6025	420	58/1473	0.75/19	25/635	1.4/0.04	7/3
TB-6625	427	64/1626	0.75/19	25/635	1.5/0.04	7/3
TB-7225	439	70/1778	0.75/19	25/635	1.6/0.05	7/3
TB-7825	528	76/1930	0.75/19	25/635	1.8/0.05	8/4

Refer to Links Fabric cards for available selections.  
For additional specification instructions see pages 6-7.





Desk Organizer Shell - 13"H

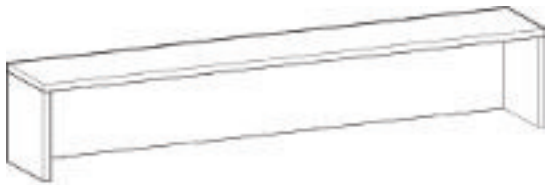

CODE	PRICE	WIDTH (in/mm)	DEPTH (in/mm)	HEIGHT (in/mm)	VOLUME (ft3/m3)	WEIGHT (lbs/kg)
------	-------	------------------	------------------	-------------------	--------------------	--------------------

SOR-1224-13	276	24/610	12/305	13/330	2/0.06	30/14
SOR-1230-13	301	30/762	12/305	13/330	3/0.08	35/16
SOR-1236-13	326	36/914	12/305	13/330	4/0.11	40/18
SOR-1242-13	354	42/1067	12/305	13/330	5/0.14	45/20
SOR-1248-13	382	48/1219	12/305	13/330	6/0.17	50/23
SOR-1254-13	409	54/1372	12/305	13/330	7/0.20	55/25
SOR-1260-13	431	60/1524	12/305	13/330	8/0.23	60/27
SOR-1266-13	461	66/1676	12/305	13/330	9/0.25	65/29
SOR-1272-13	488	72/1829	12/305	13/330	10/0.28	70/32

Desk Organizer Shell with Dividers - 13"H

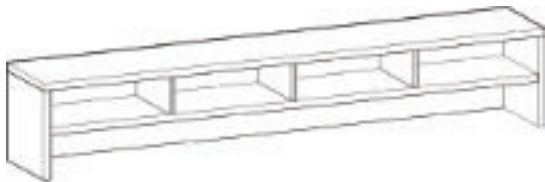

SOR-1224-13-HS	466	24/610	12/305	13/330	2/0.06	40/18
SOR-1230-13-HS	492	30/762	12/305	13/330	3/0.08	45/20
SOR-1236-13-HS	516	36/914	12/305	13/330	4/0.11	50/23
SOR-1242-13-HS	559	42/1067	12/305	13/330	5/0.14	55/25
SOR-1248-13-HS	588	48/1219	12/305	13/330	6/0.17	60/27
SOR-1254-13-HS	630	54/1372	12/305	13/330	7/0.20	65/29
SOR-1260-13-HS	658	60/1524	12/305	13/330	8/0.23	70/32
SOR-1266-13-HS	701	66/1676	12/305	13/330	9/0.25	75/34
SOR-1272-13-HS	727	72/1829	12/305	13/330	10/0.28	80/36



DIV-12-HS	49	Extra divider with pins				
-----------	----	-------------------------	--	--	--	--

Corner Organizer Shell - 13"H



SOR-3636-13	758	36/914	36/914	13/330	4/0.11	58/26
SOR-4242-13	818	42/1067	42/1067	13/330	4/0.11	67/30
SOR-4848-13	877	48/1219	48/1219	13/330	4/0.11	76/34

For additional specification instructions see page 6.

Hutch Mail Sorter - 36H



Hutch Mail Sorter. Five adjustable shelves each section.

One divider, two sections, ten adjustable shelves for 24W and 30W. Two dividers, three sections, fifteen adjustable shelves for 36W.



CODE	PRICE	WIDTH (in/mm)	DEPTH (in/mm)	HEIGHT (in/mm)	VOLUME (ft3/m3)	WEIGHT (lbs/kg)
------	-------	------------------	------------------	-------------------	--------------------	--------------------

14D	HUT-1424-36-MS	995	24/610	14/356	36/914	9/0.25	85/39
	HUT-1430-36-MS	1062	30/762	14/356	36/914	11/0.31	90/41
	HUT-1436-36-MS	1270	36/914	14/356	36/914	13/0.37	110/50
16D	HUT-1624-36-MS	1195	24/610	16/406	36/914	10/0.28	90/41
	HUT-1630-36-MS	1276	30/762	16/406	36/914	12/0.34	95/43
	HUT-1636-36-MS	1523	36/914	16/406	36/914	14/0.40	115/52

Hutch Mail Sorter - 42H

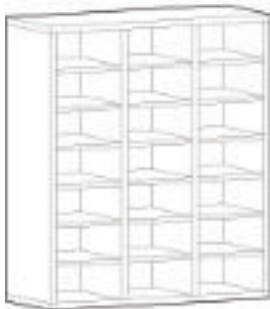

Hutch Mail Sorter. Six adjustable shelves each section.

One divider, two sections, twelve adjustable shelves for 24W and 30W. Two dividers, three sections, eighteen adjustable shelves for 36W.



14D	HUT-1424-42-MS	1202	24/610	14/356	42/1067	10/0.28	95/43
	HUT-1430-42-MS	1296	30/762	14/356	42/1067	12/0.34	100/45
	HUT-1436-42-MS	1549	36/914	14/356	42/1067	14/0.40	120/54
16D	HUT-1624-42-MS	1442	24/610	16/406	42/1067	11/0.31	100/45
	HUT-1630-42-MS	1555	30/762	16/406	42/1067	13/0.37	105/48
	HUT-1636-42-MS	1864	36/914	16/406	42/1067	15/0.42	125/57



Extra shelf with pins for mail sorter.

SHELF-14-MS24	47
SHELF-14-MS30	47
SHELF-14-MS36	47
SHELF-16-MS24	47
SHELF-16-MS30	47
SHELF-16-MS36	47

Please note: cabinet shelves are colour matched to top colour, unless otherwise specified. For additional specification instructions see page 6.

**Mail Sorter Cabinets - 48H**

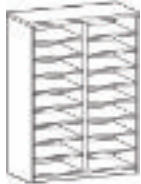

8 shelves per section.

24W and 30W cabinets have one center divider and 16 adjustable shelves.

36W cabinets have two dividers and 24 adjustable shelves



CODE	PRICE	WIDTH (in/mm)	DEPTH (in/mm)	HEIGHT (in/mm)	VOLUME (ft <sup>3</sup> /m <sup>3</sup> )	WEIGHT (lbs/kg)
------	-------	------------------	------------------	-------------------	--	--------------------

CAB-1424-48-MS	1382	24/610	14/356	48/1219	11/0.31	99/45
CAB-1430-48-MS	1490	30/762	14/356	48/1219	14/0.40	107/49
CAB-1436-48-MS	1782	36/914	14/356	48/1219	16/0.45	127/58
CAB-1624-48-MS	1658	24/610	16/406	48/1219	13/0.37	109/49
CAB-1630-48-MS	1789	30/762	16/406	48/1219	16/0.45	117/53
CAB-1636-48-MS	2142	36/914	16/406	48/1219	19/0.54	137/62

**Mail Sorter Cabinets - 66H**

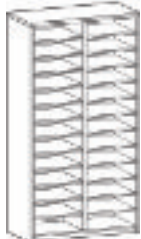

12 shelves per section.

24W and 30W cabinets have one center divider with 24 adjustable shelves.

36W cabinets have two dividers and 36 adjustable shelves



CAB-1424-66-MS	1590	24/610	14/356	66/1676	15/0.42	150/68
CAB-1430-66-MS	1716	30/762	14/356	66/1676	18/0.51	160/73
CAB-1436-66-MS	2051	36/914	14/356	66/1676	22/0.62	180/82
CAB-1624-66-MS	1910	24/610	16/406	66/1676	17/0.48	160/73
CAB-1630-66-MS	2057	30/762	16/406	66/1676	21/0.59	170/77
CAB-1636-66-MS	2464	36/914	16/406	66/1676	25/0.71	200/91

**Mail Sorter Cabinets - 72H**

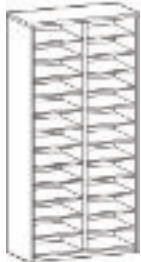

12 shelves per section.

24W and 30W cabinets have one center divider with 24 adjustable shelves.

36W cabinets have two dividers and 36 adjustable shelves



CAB-1424-72-MS	1662	24/610	14/356	72/1829	16/0.45	160/73
CAB-1430-72-MS	1789	30/762	14/356	72/1829	20/0.57	170/77
CAB-1436-72-MS	2137	36/914	14/356	72/1829	24/0.68	190/86
CAB-1624-72-MS	1991	24/610	16/406	72/1829	18/0.51	170/77
CAB-1630-72-MS	2150	30/762	16/406	72/1829	23/0.65	180/82
CAB-1636-72-MS	2570	36/914	16/406	72/1829	27/0.76	220/100



Extra shelf with pins for mail sorter.

SHELF-14-MS24	47
SHELF-14-MS30	47
SHELF-14-MS36	47
SHELF-16-MS24	47
SHELF-16-MS30	47
SHELF-16-MS36	47

Please note: cabinet shelves are colour matched to top colour, unless otherwise specified.  
For additional specification instructions see page 6-7.

**Two Drawer**



Lateral file. Two drawer. Grommet included on 24in depth units.

P  - Specify pull handle style

CODE	PRICE	WIDTH (in/mm)	DEPTH (in/mm)	HEIGHT (in/mm)	VOLUME (ft3/m3)	WEIGHT (lbs/kg)
20"	CAB-2024-LF-P	961	24/610	20/508	29/737	10/0.28 116/53
	CAB-2030-LF-P	994	30/762	20/508	29/737	12/0.34 126/57
	CAB-2036-LF-P	1026	36/914	20/508	29/737	14/0.40 136/62
24"	CAB-2424-LF-P	997	24/610	24/610	29/737	11/0.31 126/57
	CAB-2430-LF-P	1032	30/762	24/610	29/737	14/0.40 136/62
	CAB-2436-LF-P	1062	36/914	24/610	29/737	17/0.48 146/66

**Two Drawer - Mechanical Interlock**



Lateral file. Two drawer with Mechanical interlock allows only one drawer to open at a time. Grommet included on 24in depth units.

P  - Specify pull handle style

20"	CAB-2024-LF-2F-P	1034	24/610	20/508	29/737	10/0.28 116/53
	CAB-2030-LF-2F-P	1066	30/762	20/508	29/737	12/0.34 126/57
	CAB-2036-LF-2F-P	1097	36/914	20/508	29/737	14/0.40 136/62
24"	CAB-2424-LF-2F-P	1069	24/610	24/610	29/737	11/0.31 126/57
	CAB-2430-LF-2F-P	1103	30/762	24/610	29/737	14/0.40 136/62
	CAB-2436-LF-2F-P	1133	36/914	24/610	29/737	17/0.48 146/66

**Three Drawer**



Locking three drawer lateral file. Mechanical interlock allows only one drawer to open at a time. Grommet included on 24in depth units.

42H	CAB-202442-3L-P	1795	24/610	20/508	42/1067	15/0.42 178/81
	CAB-203042-3L-P	1816	30/762	20/508	42/1067	17/0.48 186/84
	CAB-203642-3L-P	1830	36/914	20/508	42/1067	20/0.57 195/88
	CAB-242442-3L-P	1830	24/610	24/610	42/1067	17/0.48 188/85
	CAB-243042-3L-P	1848	30/762	24/610	42/1067	20/0.57 196/89
	CAB-243642-3L-P	1862	36/914	24/610	42/1067	23/0.65 206/93

**Four Drawer**



Locking four drawer lateral file. Mechanical interlock allows only one drawer to open at a time. Grommet included on 24in depth units.

55H	CAB-202455-4L-P	2290	24/610	20/508	55/1397	19/0.54 226/103
	CAB-203055-4L-P	2306	30/762	20/508	55/1397	22/0.62 234/106
	CAB-203655-4L-P	2324	36/914	20/508	55/1397	26/0.74 244/111
	CAB-242455-4L-P	2315	24/610	24/610	55/1397	22/0.62 238/108
	CAB-243055-4L-P	2327	30/762	24/610	55/1397	26/0.74 246/112
	CAB-243655-4L-P	2345	36/914	24/610	55/1397	30/0.85 256/116

**Four Drawer, Open**



Locking four drawer lateral file with open compartment. Mechanical interlock allows only one drawer to open at a time. Grommet included on 24in depth units.

P  - Specify pull handle style

66H	CAB-202466-4L-P	2293	24/610	20/508	66/1676	23/0.65 269/122
	CAB-203066-4L-P	2306	30/762	20/508	66/1676	25/0.71 279/127
	CAB-203666-4L-P	2324	36/914	20/508	66/1676	30/0.85 289/131
	CAB-242466-4L-P	2312	24/610	24/610	66/1676	27/0.76 281/127
	CAB-243066-4L-P	2327	30/762	24/610	66/1676	30/0.85 291/132
	CAB-243666-4L-P	2345	36/914	24/610	66/1676	36/1.02 301/137
72H	CAB-202472-4L-P	2522	24/610	20/508	72/1829	25/0.71 280/127
	CAB-203072-4L-P	2537	30/762	20/508	72/1829	28/0.79 290/132
	CAB-203672-4L-P	2556	36/914	20/508	72/1829	33/0.93 301/137
	CAB-242472-4L-P	2544	24/610	24/610	72/1829	29/0.82 293/133
	CAB-243072-4L-P	2558	30/762	24/610	72/1829	33/0.93 303/137
	CAB-243672-4L-P	2579	36/914	24/610	72/1829	39/1.10 315/143

Please note: cabinet door, shelves and lateral file drawer fronts are colour matched to top colour, unless otherwise specified. For additional specification instructions and pull handle options see pages 6-7.



Mobile Pedestals



One box and one file drawer with ball bearing suspension on the file drawer and on box drawer. Locking drawers. Four casters.

P - Specify pull handle style

CODE	PRICE	WIDTH (in/mm)	DEPTH (in/mm)	HEIGHT (in/mm)	VOLUME (ft <sup>3</sup> /m <sup>3</sup> )	WEIGHT (lbs/kg)
------	-------	------------------	------------------	-------------------	--	--------------------

CAB-1622-LMBF	779	16/406	22/559	21/533	5/0.14	65/29
CAB-1622-LMBF-P	835	With optional handles				



One box and one file drawer with ball bearing suspension. Locking drawers. Four casters. Cushioned seat. Refer to Links Fabric cards for available fabric selection.

P - Specify pull handle style

CAB-1622-LMBF-SE	1104	16/406	22/559	24/610	6/0.17	65/29
CAB-1622-LMBF-SE-P	1160	With optional handles				

\*\*Vinyl is available upon request. Contact Customer Service for options and pricing.\*\*



Two box and one file drawer with ball bearing suspension on the file drawer and on box drawer. Locking drawers. Four casters.

P - Specify pull handle style

CAB-1622-LMBBF	862	16/406	22/559	28/711	6/0.17	80/36
CAB-1622-LMBBF-P	946	With optional handles				



Mobile pedestal on casters. Two file drawer with ball bearing suspension on both drawers. Locking drawers. Four casters.

P - Specify pull handle style

CAB-1622-LMFF	862	16/406	22/559	28/711	6/0.17	80/36
CAB-1622-LMFF-P	918	With optional handles				



Four box drawers with ball bearing suspension. Locking drawers. Four casters.

P - Specify pull handle style

CAB-1622-LM4B	944	16/406	22/559	28/711	6/0.17	80/36
CAB-1622-LM4B-P	1056	With optional handles				

For additional specification instructions and pull handle options see pages 6-7.

Refer to Links Fabric cards for available fabric selection - Vinyl is available upon request. Contact Customer Service for options and pricing.

Stationary and Fixed Pedestals



Stationary pedestal. Two box and one file drawer with ball bearing suspension on the file and on both drawers. Locking drawers.

CODE	PRICE	WIDTH (in/mm)	DEPTH (in/mm)	HEIGHT (in/mm)	VOLUME (ft3/m3)	WEIGHT (lbs/kg)
CAB-1622-LPBBF	862	16/406	22/559	28/711	6/0.17	80/36
CAB-1622-LPBBF-P	946	With optional handles				

P - Specify pull handle style

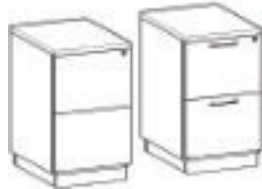

Stationary pedestal. Two file drawers with ball bearing suspension on both drawers. Locking drawers.

CAB-1622-LPFF	862	16/406	22/559	28/711	6/0.17	80/36
CAB-1622-LPFF-P	918	With optional handles				

P - Specify pull handle style

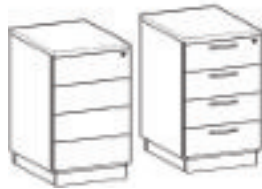

Stationary pedestal. Four box drawers with ball bearing suspension. Locking drawers.

CAB-1622-LP4B	944	16/406	22/559	28/711	6/0.17	80/36
CAB-1622-LP4B-P	1056	With optional handles				

P - Specify pull handle style



Fixed pedestal. One box and one file drawer with ball bearing suspension on the file and on box drawer. Locking drawers.

CAB-1622-LPBF	614	16/406	22/559	18/457	5/0.14	66/30
CAB-1622-LPBF-P	670	With optional handles				

P - Specify pull handle style



No-top fixed stationary pedestal. Two box and one file drawer with ball bearing suspension on the file and on both drawers. Locking drawers.

CAB-1622-LOBBF	845	16/406	22/559	28/711	6/0.17	70/32
CAB-1622-LOBBF-P	929	With optional handles				

P - Specify pull handle style



No-top fixed stationary pedestal. Two file drawers with ball bearing suspension on both drawers. Locking drawers.

CAB-1622-LOFF	845	16/406	22/559	28/711	6/0.17	70/32
CAB-1622-LOFF-P	901	With optional handles				

P - Specify pull handle style



No-top fixed stationary pedestal. Four box drawers with ball bearing suspension. Locking drawers.

CAB-1622-LO4B	928	16/406	22/559	28/711	6/0.17	70/32
CAB-1622-LO4B-P	1040	With optional handles				

P - Specify pull handle style

For additional specification instructions and pull handle options see pages 6-7.

Credenzas



Double lateral file credenza.  
P - Specify pull handle style

			WIDTH	DEPTH	HEIGHT	VOLUME	WEIGHT
CODE	PRICE	(in/mm)	(in/mm)	(in/mm)	(ft3/m3)	(lbs/kg)	
20"	CAB-2060-LFLF-P	1996	60/1524	20/508	29/737	24/0.68	252/114
	CAB-2072-LFLF-P	2056	72/1829	20/508	29/737	28/0.79	261/118
24"	CAB-2460-LFLF-P	2056	60/1524	24/610	29/737	25/0.71	262/119
	CAB-2472-LFLF-P	2075	72/1829	24/610	29/737	29/0.82	271/123



Double mini lateral file credenza.  
P - Specify pull handle style

20"	CAB-2060-MLML-P	1996	60/1524	20/508	29/737	24/0.68	252/114
	CAB-2072-MLML-P	2056	72/1829	20/508	29/737	28/0.79	261/118
24"	CAB-2460-MLML-P	2056	60/1524	24/610	29/737	25/0.71	262/119
	CAB-2472-MLML-P	2075	72/1829	24/610	29/737	29/0.82	271/123

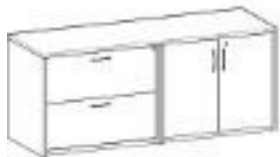

Lateral file storage credenza. One adjustable shelf in storage cabinet.  
P - Specify pull handle style

20"	CAB-2060-LFSC-P	1793	60/1524	20/508	29/737	24/0.68	227/103
	CAB-2072-LFSC-P	1842	72/1829	20/508	29/737	28/0.79	236/107
24"	CAB-2460-LFSC-P	1841	60/1524	24/610	29/737	25/0.71	237/108
	CAB-2472-LFSC-P	1858	72/1829	24/610	29/737	29/0.82	246/112

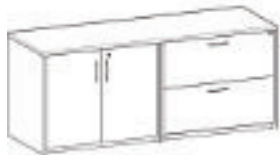

Storage lateral file credenza. One adjustable shelf in storage cabinet.  
P - Specify pull handle style

20"	CAB-2060-SCLF-P	1793	60/1524	20/508	29/737	24/0.68	227/103
	CAB-2072-SCLF-P	1842	72/1829	20/508	29/737	28/0.79	236/107
24"	CAB-2460-SCLF-P	1841	60/1524	24/610	29/737	25/0.71	237/108
	CAB-2472-SCLF-P	1858	72/1829	24/610	29/737	29/0.82	246/112



Double storage cabinet credenza. One adjustable shelf in each storage cabinet.  
P - Specify pull handle style

20"	CAB-2060-SCSC-P	1613	60/1524	20/508	29/737	24/0.68	197/89
	CAB-2072-SCSC-P	1658	72/1829	20/508	29/737	28/0.79	206/93
24"	CAB-2460-SCSC-P	1630	60/1524	24/610	29/737	25/0.71	207/94
	CAB-2472-SCSC-P	1676	72/1829	24/610	29/737	29/0.82	216/98



Double mini storage cabinet credenza.  
P - Specify pull handle style

20"	CAB-2060-MSMS-P	1613	60/1524	20/508	29/737	24/0.68	197/89
	CAB-2072-MSMS-P	1658	72/1829	20/508	29/737	28/0.79	206/93
24"	CAB-2460-MSMS-P	1630	60/1524	24/610	29/737	25/0.71	207/94
	CAB-2472-MSMS-P	1676	72/1829	24/610	29/737	29/0.82	216/98

For additional specification instructions and pull handle options see pages 6-7.

Credenzas

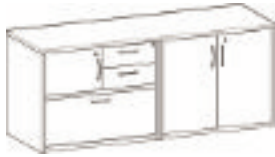

Multifunctional storage credenza. Multifunction cabinet with left storage, 2 box drawers, and 1 lateral file. One adjustable shelf in storage cabinet.

P - Specify pull handle style

CODE	PRICE	WIDTH (in/mm)	DEPTH (in/mm)	HEIGHT (in/mm)	VOLUME (ft3/m3)	WEIGHT (lbs/kg)
20" CAB-2060-MFSC-P	2146	60/1524	20/508	29/737	24/0.68	233/106
CAB-2072-MFSC-P	2196	72/1829	20/508	29/737	28/0.79	253/115
24" CAB-2460-MFSC-P	2192	60/1524	24/610	29/737	25/0.71	263/119
CAB-2472-MFSC-P	2212	72/1829	24/610	29/737	29/0.82	273/124



Storage multifunctional credenza. One adjustable shelf in storage cabinet. Multifunction cabinet with right storage, 2 box drawers, and 1 lateral file.

P - Specify pull handle style

20" CAB-2060-SCMF-P	2146	60/1524	20/508	29/737	24/0.68	233/106
CAB-2072-SCMF-P	2196	72/1829	20/508	29/737	28/0.79	253/115
24" CAB-2460-SCMF-P	2192	60/1524	24/610	29/737	25/0.71	263/119
CAB-2472-SCMF-P	2212	72/1829	24/610	29/737	29/0.82	273/124



Multifunctional lateral file credenza. Multifunction cabinet with left storage, 2 box drawers, and 1 lateral file. Two drawer lateral file.

P - Specify pull handle style

20" CAB-2060-MFLF-P	2350	60/1524	20/508	29/737	24/0.68	262/119
CAB-2072-MFLF-P	2410	72/1829	20/508	29/737	28/0.79	282/128
24" CAB-2460-MFLF-P	2408	60/1524	24/610	29/737	25/0.71	282/128
CAB-2472-MFLF-P	2430	72/1829	24/610	29/737	29/0.82	302/137



Lateral file multifunctional credenza. Two drawer lateral file. Multifunction cabinet with right storage, 2 box drawers, and 1 lateral file.

P - Specify pull handle style

20" CAB-2060-LFMF-P	2350	60/1524	20/508	29/737	24/0.68	262/119
CAB-2072-LFMF-P	2410	72/1829	20/508	29/737	28/0.79	282/128
24" CAB-2460-LFMF-P	2408	60/1524	24/610	29/737	25/0.71	282/128
CAB-2472-LFMF-P	2430	72/1829	24/610	29/737	29/0.82	302/137

Buffet Credenza



Box drawers, non locking. Locking Storage with one adjustable shelf in each compartment.

P - Specify pull handle style

CAB-2060-36-SC2B-P	2782	60/1524	20/508	36/914	30/0.85	285/129
CAB-2072-36-SC2B-P	2828	72/1829	20/508	36/914	35/0.99	295/134
CAB-2460-36-SC2B-P	2813	60/1524	24/610	36/914	30/0.85	300/136
CAB-2472-36-SC2B-P	2860	72/1829	24/610	36/914	39/1.10	310/141

For additional specification instructions and pull handle options see pages 6-7.

Rectangular Top (for no top cabinets)



CODE	PRICE	WIDTH (in/mm)	DEPTH (in/mm)	HEIGHT (in/mm)	VOLUME (ft3/m3)	WEIGHT (lbs/kg)
TOP-2024	117	24/610	20/508	1/25	0.9/0.03	12/5
TOP-2030	146	30/762	20/508	1/25	1.2/0.03	15/7
TOP-2036	175	36/914	20/508	1/25	1.4/0.04	18/8
TOP-2042	204	42/1067	20/508	1/25	1.6/0.05	20/9
TOP-2048	233	48/1219	20/508	1/25	1.8/0.05	23/10
TOP-2054	263	54/1372	20/508	1/25	2.0/0.06	26/12
TOP-2060	292	60/1524	20/508	1/25	2.3/0.07	29/13
TOP-2066	321	66/1676	20/508	1/25	2.5/0.07	32/15
TOP-2072	350	72/1829	20/508	1/25	2.7/0.08	35/16
TOP-2078	379	78/1981	20/508	1/25	2.9/0.08	38/17
TOP-2084	408	84/2134	20/508	1/25	3.1/0.09	41/19
TOP-2096	467	96/2438	20/508	1/25	3.6/0.10	47/21



TOP-2424	140	24/610	24/610	1/25	1.1/0.03	14/6
TOP-2430	175	30/762	24/610	1/25	1.4/0.04	18/8
TOP-2436	210	36/914	24/610	1/25	1.6/0.05	21/10
TOP-2442	245	42/1067	24/610	1/25	1.9/0.05	25/11
TOP-2448	280	48/1219	24/610	1/25	2.2/0.06	28/13
TOP-2454	315	54/1372	24/610	1/25	2.4/0.07	32/15
TOP-2460	350	60/1524	24/610	1/25	2.7/0.08	35/16
TOP-2466	385	66/1676	24/610	1/25	2.9/0.08	39/18
TOP-2472	420	72/1829	24/610	1/25	3.2/0.09	42/19
TOP-2478	455	78/1981	24/610	1/25	3.5/0.10	46/21
TOP-2484	490	84/2134	24/610	1/25	3.7/0.10	49/22
TOP-2496	560	96/2438	24/610	1/25	4.3/0.12	56/25

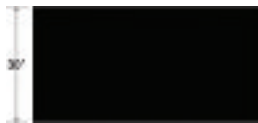

TOP-3030	219	30/762	30/762	1/25	1.7/0.05	22/10
TOP-3036	263	36/914	30/762	1/25	2.0/0.06	26/12
TOP-3042	306	42/1067	30/762	1/25	2.3/0.07	31/14
TOP-3048	350	48/1219	30/762	1/25	2.7/0.08	35/16
TOP-3054	394	54/1372	30/762	1/25	3.0/0.08	39/18
TOP-3060	438	60/1524	30/762	1/25	3.3/0.09	44/20
TOP-3066	481	66/1676	30/762	1/25	3.6/0.10	48/22
TOP-3072	525	72/1829	30/762	1/25	4.0/0.11	53/24
TOP-3078	569	78/1981	30/762	1/25	4.3/0.12	57/26
TOP-3084	613	84/2134	30/762	1/25	4.6/0.13	61/28
TOP-3096	700	96/2438	30/762	1/25	5.3/0.15	70/32

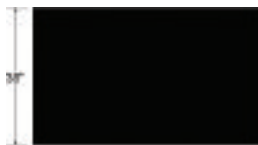

TOP-3636	315	36/914	36/914	1/25	2.4/0.07	32/15
TOP-3642	368	42/1067	36/914	1/25	2.8/0.08	37/17
TOP-3648	420	48/1219	36/914	1/25	3.2/0.09	42/19
TOP-3654	473	54/1372	36/914	1/25	3.6/0.10	47/21
TOP-3660	525	60/1524	36/914	1/25	4.0/0.11	53/24
TOP-3666	578	66/1676	36/914	1/25	4.3/0.12	58/26
TOP-3672	630	72/1829	36/914	1/25	4.7/0.13	63/29
TOP-3678	683	78/1981	36/914	1/25	5.1/0.14	68/31
TOP-3684	735	84/2134	36/914	1/25	5.5/0.16	74/34
TOP-3696	840	96/2438	36/914	1/25	6.3/0.18	84/38

IN ORDER FOR WORKSURFACE TO BE PRE-DRILLED BY FACTORY, PLEASE SPECIFY NO TOP CABINET WIDTH(S) INTENDED FOR USE AS BASE OTHERWISE ASSEMBLY MAY REQUIRE INSTALLER SUPPLIED 'L' BRACKETS

For additional specification instructions and pull handle options see pages 6-7.



No Top Cabinets - 28"H

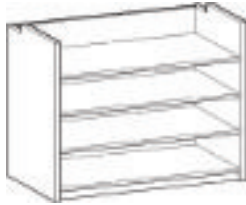

Bookcase with three adjustable shelves. Installed under 24"D and 30"D work surface.

CODE	PRICE	WIDTH (in/mm)	DEPTH (in/mm)	HEIGHT (in/mm)	VOLUME (ft3/m3)	WEIGHT (lbs/kg)
CAB-2018-OS-NT	750	18/457	20/508	28/711	8/0.23	110/50
CAB-2024-OS-NT	764	24/610	20/508	28/711	10/0.28	116/53
CAB-2030-OS-NT	797	30/762	20/508	28/711	12/0.34	126/57
CAB-2036-OS-NT	828	36/914	20/508	28/711	14/0.40	136/62



Storage cabinet with locking doors, one adjustable shelf. Installed under 24"D and 30"D work surface.

P - Specify pull handle style



L

R

CAB-2018-L-SC-NT-P	750	18/457	20/508	28/711	8/0.23	75/34
CAB-2018-R-SC-NT-P	750	18/457	20/508	28/711	8/0.23	75/34
CAB-2024-L-SC-NT-P	764	24/610	20/508	28/711	10/0.28	81/37
CAB-2024-R-SC-NT-P	764	24/610	20/508	28/711	10/0.28	81/37
CAB-2030-SC-NT-P	797	30/762	20/508	28/711	12/0.34	91/41
CAB-2036-SC-NT-P	828	36/914	20/508	28/711	14/0.40	101/46



Multifunction cabinet with left or right storage, 2 box drawers, 1 lateral file. Installed under 24"D, 30"D work surface.

P - Specify pull handle style



L

R

CAB-2030-L-LMFC-NT-P	1348	30/762	20/508	28/711	12/0.34	130/59
CAB-2030-R-LMFC-NT-P	1348	30/762	20/508	28/711	12/0.34	130/59
CAB-2036-L-LMFC-NT-P	1381	36/914	20/508	28/711	14/0.40	140/64
CAB-2036-R-LMFC-NT-P	1381	36/914	20/508	28/711	14/0.40	140/64



Multifunction cabinet with left or right file, 2 box drawers, and 1 lateral file. Installed under 24"D and 30"D work surface.

P - Specify pull handle style

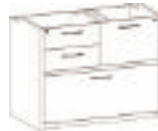

L

R

CAB-2036-L-LMFD-NT-P	1517	36/914	20/508	28/711	14/0.40	140/64
CAB-2036-R-LMFD-NT-P	1517	36/914	20/508	28/711	14/0.40	140/64



Lateral file. Two drawer. Installed under 24"D and 30"D work surface.

P - Specify pull handle style

CAB-2024-LF-NT-P	961	24/610	20/508	28/711	10/0.28	110/50
CAB-2030-LF-NT-P	994	30/762	20/508	28/711	12/0.34	120/54
CAB-2036-LF-NT-P	1026	36/914	20/508	28/711	14/0.40	130/59

For additional specification instructions and pull handle options see pages 6-7.

Cabinets - 29"H



Storage cabinet with locking doors, one adjustable shelf. Grommet included on 24in depth units.

P - Specify pull handle style

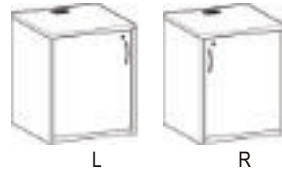

CODE	PRICE	WIDTH (in/mm)	DEPTH (in/mm)	HEIGHT (in/mm)	VOLUME (ft3/m3)	WEIGHT (lbs/kg)
20"	CAB-2018-L-SC-P	750	18/457	20/508	29/737	8/0.23 75/34
	CAB-2018-R-SC-P	750	18/457	20/508	29/737	8/0.23 75/34
	CAB-2024-L-SC-P	764	24/610	20/508	29/737	10/0.28 87/39
	CAB-2024-R-SC-P	764	24/610	20/508	29/737	10/0.28 87/39
	CAB-2030-SC-P	797	30/762	20/508	29/737	12/0.34 97/44
	CAB-2036-SC-P	828	36/914	20/508	29/737	14/0.40 107/49
24"	CAB-2418-L-SC-P	785	18/457	24/610	29/737	10/0.28 91/41
	CAB-2418-R-SC-P	785	18/457	24/610	29/737	10/0.28 91/41
	CAB-2424-L-SC-P	800	24/610	24/610	29/737	11/0.31 97/44
	CAB-2424-R-SC-P	800	24/610	24/610	29/737	11/0.31 97/44
	CAB-2430-SC-P	833	30/762	24/610	29/737	14/0.40 107/49
	CAB-2436-SC-P	864	36/914	24/610	29/737	17/0.48 117/53



Bookcase with three adjustable shelves. Grommet included on 24in depth units.

20"	CAB-2018-OS	750	18/457	20/508	29/737	8/0.23 110/50
	CAB-2024-OS	764	24/610	20/508	29/737	10/0.28 116/53
	CAB-2030-OS	797	30/762	20/508	29/737	12/0.34 126/57
	CAB-2036-OS	828	36/914	20/508	29/737	14/0.40 136/62
24"	CAB-2418-OS	785	18/457	24/610	29/737	9/0.25 120/54
	CAB-2424-OS	800	24/610	24/610	29/737	11/0.31 126/57
	CAB-2430-OS	833	30/762	24/610	29/737	14/0.40 136/62
	CAB-2436-OS	864	36/914	24/610	29/737	17/0.48 146/66



Multifunction cabinet with left or right storage, 2 box drawers, and 1 lateral file. Grommet included on 24D units.

P - Specify pull handle style



20"	CAB-2030-L-LMFC-P	1348	30/762	20/508	29/737	12/0.34 136/62
	CAB-2030-R-LMFC-P	1348	30/762	20/508	29/737	12/0.34 136/62
	CAB-2036-L-LMFC-P	1381	36/914	20/508	29/737	14/0.40 146/66
	CAB-2036-R-LMFC-P	1381	36/914	20/508	29/737	14/0.40 146/66
24"	CAB-2430-L-LMFC-P	1384	30/762	24/610	29/737	14/0.40 146/66
	CAB-2430-R-LMFC-P	1384	30/762	24/610	29/737	14/0.40 146/66
	CAB-2436-L-LMFC-P	1417	36/914	24/610	29/737	17/0.48 156/71
	CAB-2436-R-LMFC-P	1417	36/914	24/610	29/737	17/0.48 156/71



Multifunction cabinet with left or right file, 2 box drawers, and 1 lateral file. Grommet included on 24D units.

P - Specify pull handle style



24"	CAB-2036-L-LMFD-P	1517	36/914	20/508	29/737	14/0.40 146/66
	CAB-2036-R-LMFD-P	1517	36/914	20/508	29/737	14/0.40 146/66
	CAB-2436-L-LMFD-P	1549	36/914	24/610	29/737	14/0.40 146/66
	CAB-2436-R-LMFD-P	1549	36/914	24/610	29/737	14/0.40 146/66

For additional specification instructions and pull handle options see pages 6-7.

Cabinets - 29"H



Open Compartment, Mini Storage Cabinet. Grommet included on 24in depth units.

P  - Specify pull handle style



L

R

CODE	PRICE	WIDTH (in/mm)	DEPTH (in/mm)	HEIGHT (in/mm)	VOLUME (ft3/m3)	WEIGHT (lbs/kg)
20"	CAB-2018-L-SO-P	750	18/457	20/508	29/737	8/0.23 86/39
	CAB-2018-R-SO-P	750	18/457	20/508	29/737	8/0.23 86/39
	CAB-2024-L-SO-P	764	24/610	20/508	29/737	10/0.28 92/42
	CAB-2024-R-SO-P	764	24/610	20/508	29/737	10/0.28 92/42
	CAB-2030-SO-P	797	30/762	20/508	29/737	12/0.34 102/46
	CAB-2036-SO-P	828	36/914	20/508	29/737	14/0.40 112/51
24"	CAB-2418-L-SO-P	785	18/457	24/610	29/737	9/0.25 96/44
	CAB-2418-R-SO-P	785	18/457	24/610	29/737	9/0.25 96/44
	CAB-2424-L-SO-P	800	24/610	24/610	29/737	11/0.31 102/46
	CAB-2424-R-SO-P	800	24/610	24/610	29/737	11/0.31 102/46
	CAB-2430-SO-P	833	30/762	24/610	29/737	14/0.40 112/51
	CAB-2436-SO-P	864	36/914	24/610	29/737	17/0.48 122/55



Open Compartment, One Lateral File Drawer. Grommet included on 24in depth units.

P  - Specify pull handle style

20"	CAB-2024-LO-P	800	24/610	20/508	29/737	10/0.28 110/50
	CAB-2030-LO-P	833	30/762	20/508	29/737	12/0.34 120/54
	CAB-2036-LO-P	864	36/914	20/508	29/737	14/0.40 130/59
24"	CAB-2424-LO-P	835	24/610	24/610	29/737	11/0.31 120/54
	CAB-2430-LO-P	866	30/762	24/610	29/737	14/0.40 130/59
	CAB-2436-LO-P	899	36/914	24/610	29/737	17/0.48 140/64



Organizer, Mini Storage Cabinet. Grommet included on 24in depth units.

P  - Specify pull handle style

CAB-2036-SD-P	1097	36/914	20/508	29/737	14/0.40	136/62
CAB-2436-SD-P	1133	36/914	24/610	29/737	17/0.48	146/66



Organizer, One Lateral File Drawer. Grommet included on 24in depth units.

P  - Specify pull handle style

CAB-2036-LD-P	1132	36/914	20/508	29/737	14/0.40	136/62
CAB-2436-LD-P	1170	36/914	24/610	29/737	17/0.48	146/66

For additional specification instructions and pull handle options see pages 6-7.

Cabinets - 36"H



Storage cabinet with locking doors, one adjustable shelf. Grommet included on 24in depth units.

P - Specify pull handle style



L



R

CODE	PRICE	WIDTH (in/mm)	DEPTH (in/mm)	HEIGHT (in/mm)	VOLUME (ft3/m3)	WEIGHT (lbs/kg)
CAB-2018-36-L-SC-P	997	18/457	20/508	36/914	12/0.34	102/46
CAB-2018-36-R-SC-P	997	18/457	20/508	36/914	12/0.34	102/46
CAB-2024-36-L-SC-P	1012	24/610	20/508	36/914	13/0.37	108/49
CAB-2024-36-R-SC-P	1012	24/610	20/508	36/914	13/0.37	108/49
CAB-2030-36-SC-P	1043	30/762	20/508	36/914	14/0.40	120/54
CAB-2036-36-SC-P	1084	36/914	20/508	36/914	14/0.40	132/60
CAB-2418-36-L-SC-P	1033	18/457	24/610	36/914	13/0.37	112/51
CAB-2418-36-R-SC-P	1033	18/457	24/610	36/914	13/0.37	112/51
CAB-2424-36-L-SC-P	1045	24/610	24/610	36/914	14/0.40	118/54
CAB-2424-36-R-SC-P	1045	24/610	24/610	36/914	14/0.40	118/54
CAB-2430-36-SC-P	1080	30/762	24/610	36/914	18/0.51	130/59
CAB-2436-36-SC-P	1120	36/914	24/610	36/914	20/0.57	142/64

Cabinets - 36"H Glazed



Storage cabinet with glazed doors, one adjustable shelf. Grommet included on 24in depth units.

P - Specify pull handle style



L



R

CAB-2024-36-L-Z-P	1578	24/610	20/508	36/914	13/0.37	108/49
CAB-2024-36-R-Z-P	1578	24/610	20/508	36/914	13/0.37	108/49
CAB-2030-36-Z-P	1620	30/762	20/508	36/914	14/0.40	120/54
CAB-2036-36-Z-P	1651	36/914	20/508	36/914	14/0.40	132/60
CAB-2424-36-L-Z-P	1614	24/610	24/610	36/914	14/0.40	118/54
CAB-2424-36-R-Z-P	1614	24/610	24/610	36/914	14/0.40	118/54
CAB-2430-36-Z-P	1648	30/762	24/610	36/914	18/0.51	130/59
CAB-2436-36-Z-P	1691	36/914	24/610	36/914	20/0.57	142/64

Z - Specify door frame colour

SZ = Silver frame

BZ = Black frame

WZ = White frame

Buffet Cabinets - 36"H



Buffet cabinet. Storage with locking doors, one adjustable shelf. One drawer. Grommet included on 24in depth units.

P - Specify pull handle style

CAB-2030-36-SC1B-P	1396	30/762	20/508	36/914	14/0.40	120/54
CAB-2036-36-SC1B-P	1417	36/914	20/508	36/914	14/0.40	132/60
CAB-2430-36-SC1B-P	1409	30/762	24/610	36/914	18/0.51	130/59
CAB-2436-36-SC1B-P	1432	36/914	24/610	36/914	20/0.57	142/64

For additional specification instructions and pull handle options see pages 6-7.







42"H Cabinets



Storage Cabinet with 2 adjustable shelves. Grommet included on 24in depth units.

P - Specify pull handle style



L

R

CODE	PRICE	WIDTH (in/mm)	DEPTH (in/mm)	HEIGHT (in/mm)	VOLUME (ft3/m3)	WEIGHT (lbs/kg)
20"	CAB-2018-42-L-SC-P	1074	18/457	20/508	42/1067	14/0.40 112/51
	CAB-2018-42-R-SC-P	1074	18/457	20/508	42/1067	14/0.40 112/51
	CAB-2024-42-L-SC-P	1088	24/610	20/508	42/1067	15/0.42 118/54
	CAB-2024-42-R-SC-P	1088	24/610	20/508	42/1067	15/0.42 118/54
	CAB-2030-42-SC-P	1121	30/762	20/508	42/1067	16/0.45 130/59
	CAB-2036-42-SC-P	1159	36/914	20/508	42/1067	20/0.57 142/64
24"	CAB-2418-42-L-SC-P	1110	18/457	24/610	42/1067	15/0.42 122/55
	CAB-2418-42-R-SC-P	1110	18/457	24/610	42/1067	15/0.42 122/55
	CAB-2424-42-L-SC-P	1123	24/610	24/610	42/1067	16/0.45 128/58
	CAB-2424-42-R-SC-P	1123	24/610	24/610	42/1067	16/0.45 128/58
	CAB-2430-42-SC-P	1157	30/762	24/610	42/1067	19/0.54 140/64
	CAB-2436-42-SC-P	1196	36/914	24/610	42/1067	23/0.65 152/69



Storage Cabinet/Bookcase with mini storage, one adjustable shelf. Grommet included on 24D units.

P - Specify pull handle style



L

R

20"	CAB-2018-42-L-SO-P	1067	18/457	20/508	42/1067	14/0.40 112/51
	CAB-2018-42-R-SO-P	1067	18/457	20/508	42/1067	14/0.40 112/51
	CAB-2024-42-L-SO-P	1082	24/610	20/508	42/1067	15/0.42 118/54
	CAB-2024-42-R-SO-P	1082	24/610	20/508	42/1067	15/0.42 118/54
	CAB-2030-42-SO-P	1121	30/762	20/508	42/1067	16/0.45 130/59
	CAB-2036-42-SO-P	1159	36/914	20/508	42/1067	20/0.57 142/64
24"	CAB-2418-42-L-SO-P	1100	18/457	24/610	42/1067	15/0.42 122/55
	CAB-2418-42-R-SO-P	1100	18/457	24/610	42/1067	15/0.42 122/55
	CAB-2424-42-L-SO-P	1116	24/610	24/610	42/1067	16/0.45 128/58
	CAB-2424-42-R-SO-P	1116	24/610	24/610	42/1067	16/0.45 128/58
	CAB-2430-42-SO-P	1157	30/762	24/610	42/1067	19/0.54 140/64
	CAB-2436-42-SO-P	1196	36/914	24/610	42/1067	23/0.65 152/69



Storage Cabinet with one open compartment, one adjustable shelf. Grommet included on 24D units.

P - Specify pull handle style



L

R

20"	CAB-2018-42-L-SCO-P	1067	18/457	20/508	42/1067	12/0.34 112/51
	CAB-2018-42-R-SCO-P	1067	18/457	20/508	42/1067	12/0.34 112/51
	CAB-2024-42-L-SCO-P	1082	24/610	20/508	42/1067	13/0.37 118/54
	CAB-2024-42-R-SCO-P	1082	24/610	20/508	42/1067	13/0.37 118/54
	CAB-2030-42-SCO-P	1121	30/762	20/508	42/1067	16/0.45 130/59
	CAB-2036-42-SCO-P	1159	36/914	20/508	42/1067	20/0.57 142/64
24"	CAB-2418-42-L-SCO-P	1100	18/457	24/610	42/1067	14/0.40 122/55
	CAB-2418-42-R-SCO-P	1100	18/457	24/610	42/1067	14/0.40 122/55
	CAB-2424-42-L-SCO-P	1116	24/610	24/610	42/1067	15/0.42 128/58
	CAB-2424-42-R-SCO-P	1116	24/610	24/610	42/1067	15/0.42 128/58
	CAB-2430-42-SCO-P	1157	30/762	24/610	42/1067	19/0.54 140/64
	CAB-2436-42-SCO-P	1196	36/914	24/610	42/1067	23/0.65 152/69

For additional specification instructions and pull handle options see pages 6-7.

42"H Cabinets



Storage Cabinet with two adj. shelves, non-locking glazed doors. Grommet included on 24D units.

P - Specify pull handle style



L R

CODE	PRICE	WIDTH (in/mm)	DEPTH (in/mm)	HEIGHT (in/mm)	VOLUME (ft3/m3)	WEIGHT (lbs/kg)
------	-------	---------------	---------------	----------------	-----------------	-----------------

20"	CAB-2024-42-L-Z-P	1656	24/610	20/508	42/1067	13/0.37 118/54
	CAB-2024-42-R-Z-P	1656	24/610	20/508	42/1067	13/0.37 118/54
	CAB-2030-42-Z-P	1699	30/762	20/508	42/1067	16/0.45 130/59
	CAB-2036-42-Z-P	1729	36/914	20/508	42/1067	19/0.54 142/64
24"	CAB-2424-42-L-Z-P	1691	24/610	24/610	42/1067	15/0.42 128/58
	CAB-2424-42-R-Z-P	1691	24/610	24/610	42/1067	15/0.42 128/58
	CAB-2430-42-Z-P	1726	30/762	24/610	42/1067	19/0.54 140/64
	CAB-2436-42-Z-P	1768	36/914	24/610	42/1067	23/0.65 152/69

Z - Specify door frame colour

SZ = Silver frame

WZ = White frame

BZ = Black frame



Mini Lateral Cabinet/Bookcase with one lateral file drawer and one adjustable shelf. Grommet included on 24in depth units.

P - Specify pull handle style

20"	CAB-2024-42-LO-P	1123	24/610	20/508	42/1067	13/0.37 126/57
	CAB-2030-42-LO-P	1157	30/762	20/508	42/1067	16/0.45 148/67
	CAB-2036-42-LO-P	1189	36/914	20/508	42/1067	20/0.57 160/73
24"	CAB-2424-42-LO-P	1159	24/610	24/610	42/1067	15/0.42 146/66
	CAB-2430-42-LO-P	1193	30/762	24/610	42/1067	19/0.54 158/72
	CAB-2436-42-LO-P	1225	36/914	24/610	42/1067	23/0.65 170/77



Two Drawer Lateral File with open compartment. Mechanical interlock allows only one drawer to open at a time. Grommet included on 24in depth units.

P - Specify pull handle style

20"	CAB-2024-42-LFO-P	1358	24/610	20/508	42/1067	13/0.37 146/66
	CAB-2030-42-LFO-P	1392	30/762	20/508	42/1067	16/0.45 158/72
	CAB-2036-42-LFO-P	1423	36/914	20/508	42/1067	20/0.57 180/82
24"	CAB-2424-42-LFO-P	1394	24/610	24/610	42/1067	15/0.42 160/73
	CAB-2430-42-LFO-P	1427	30/762	24/610	42/1067	19/0.54 168/76
	CAB-2436-42-LFO-P	1460	36/914	24/610	42/1067	23/0.65 190/86



Extra 5/8" shelf with pins for cabinets.

20"	CAB-2018-SHELF	85	16/405	19/483	.63/16	0.6/0.2 8/4
	CAB-2024-SHELF	85	22/559	19/483	.63/16	0.8/0.23 10/5
	CAB-2030-SHELF	90	28/711	19/483	.63/16	1.0/0.3 12/5
	CAB-2036-SHELF	90	34/864	19/483	.63/16	1.25/0.4 14/6
24"	CAB-2418-SHELF	90	16/406	23/584	.63/16	0.75/0.2 9/4
	CAB-2424-SHELF	90	22/559	23/584	.63/16	1.0/0.3 11/5
	CAB-2430-SHELF	95	28/711	23/584	.63/16	1.25/0.4 13/6
	CAB-2436-SHELF	95	34/864	23/584	.63/16	1.5/0.4 15/7

For additional specification instructions and pull handle options see pages 6-7.



Vertical lateral file and bookcase. Locking lateral file drawers. Two adjustable shelves in bookcase. Grommet included on 24in depth units.

P  - Specify pull handle style

CODE	PRICE	WIDTH (in/mm)	DEPTH (in/mm)	HEIGHT (in/mm)	VOLUME (ft3/m3)	WEIGHT (lbs/kg)
66H	CAB-202466-LB-P	1606	24/610	20/508	66/1676	23/0.65 222/101
	CAB-203066-LB-P	1620	30/762	20/508	66/1676	25/0.71 232/105
	CAB-203666-LB-P	1665	36/914	20/508	66/1676	30/0.85 242/110
	CAB-242466-LB-P	1688	24/610	24/610	66/1676	27/0.76 234/106
	CAB-243066-LB-P	1703	30/762	24/610	66/1676	30/0.85 244/111
	CAB-243666-LB-P	1800	36/914	24/610	66/1676	36/1.02 254/115
72H	CAB-202472-LB-P	1768	24/610	20/508	72/1829	25/0.71 233/106
	CAB-203072-LB-P	1783	30/762	20/508	72/1829	28/0.79 243/110
	CAB-203672-LB-P	1819	36/914	20/508	72/1829	33/0.93 254/115
	CAB-242472-LB-P	1860	24/610	24/610	72/1829	29/0.82 246/112
	CAB-243072-LB-P	1873	30/762	24/610	72/1829	33/0.93 256/116
	CAB-243672-LB-P	1980	36/914	24/610	72/1829	39/1.10 268/122



Open bookcase w/ four adjustable shelves. Grommet included on 24in depth units.

66H	CAB-202466-OB	1298	24/610	20/508	66/1676	23/0.65 166/75
	CAB-203066-OB	1312	30/762	20/508	66/1676	25/0.71 176/80
	CAB-203666-OB	1328	36/914	20/508	66/1676	30/0.85 186/84
	CAB-242466-OB	1316	24/610	24/610	66/1676	27/0.76 178/81
	CAB-243066-OB	1331	30/762	24/610	66/1676	30/0.85 188/85
	CAB-243666-OB	1348	36/914	24/610	66/1676	36/1.02 198/90
72H	CAB-202472-OB	1427	24/610	20/508	72/1829	25/0.71 177/80
	CAB-203072-OB	1441	30/762	20/508	72/1829	28/0.79 187/85
	CAB-203672-OB	1462	36/914	20/508	72/1829	33/0.93 198/90
	CAB-242472-OB	1450	24/610	24/610	72/1829	29/0.82 190/86
	CAB-243072-OB	1464	30/762	24/610	72/1829	33/0.93 200/91
	CAB-243672-OB	1483	36/914	24/610	72/1829	39/1.10 212/96

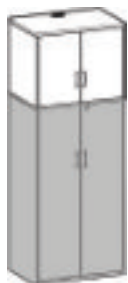

Vertical cabinet extension. 27"H with one adjustable shelf. Grommet included on 24in depth units.

P  - Specify pull handle style

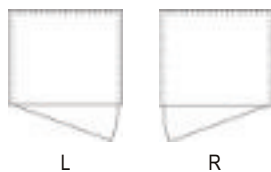

20"D	CAB-202427-L-VS-HE-P	487	24/610	20/508	27/686	9/0.25 51/23
	CAB-202427-R-VS-HE-P	487	24/610	20/508	27/686	9/0.25 51/23
	CAB-203027-VS-HE-P	502	30/762	20/508	27/686	11/0.31 56/25
	CAB-203627-VS-HE-P	666	36/914	20/508	27/686	13/0.37 66/30
24"D	CAB-242427-L-VS-HE-P	656	24/610	24/610	27/686	11/0.31 63/29
	CAB-242427-R-VS-HE-P	656	24/610	24/610	27/686	11/0.31 63/29
	CAB-243027-VS-HE-P	670	30/762	24/610	27/686	13/0.37 68/31
	CAB-243627-VS-HE-P	701	36/914	24/610	27/686	15/0.42 78/35

Please note: cabinet door, shelves and lateral file drawer fronts are colour matched to top colour, unless otherwise specified. For additional specification instructions and pull handle options see pages 6-7.



Vertical storage cabinet and bookcase. Locking storage cabinet with one adjustable shelf. Two adjustable shelves in bookcase. Grommet included on 24in depth units.

P - Specify pull handle style

CODE	PRICE	WIDTH (in/mm)	DEPTH (in/mm)	HEIGHT (in/mm)	VOLUME (ft3/m3)	WEIGHT (lbs/kg)
66H CAB-202466-L-SB-P	1523	24/610	20/508	66/1676	20/0.57	191/87
CAB-202466-R-SB-P	1523	24/610	20/508	66/1676	20/0.57	191/87
CAB-203066-SB-P	1565	30/762	20/508	66/1676	25/0.71	201/91
66H CAB-203666-SB-P	1596	36/914	20/508	66/1676	30/0.85	211/96
CAB-242466-L-SB-P	1590	24/610	24/610	66/1676	24/0.68	203/92
CAB-242466-R-SB-P	1590	24/610	24/610	66/1676	24/0.68	203/92
CAB-243066-SB-P	1630	30/762	24/610	66/1676	30/0.85	213/97
CAB-243666-SB-P	1661	36/914	24/610	66/1676	36/1.02	223/101
72H CAB-202472-L-SB-P	1680	24/610	20/508	72/1829	22/0.62	202/92
CAB-202472-R-SB-P	1680	24/610	20/508	72/1829	22/0.62	202/92
CAB-203072-SB-P	1720	30/762	20/508	72/1829	28/0.79	212/96
72H CAB-203672-SB-P	1758	36/914	20/508	72/1829	33/0.93	223/101
CAB-242472-L-SB-P	1753	24/610	24/610	72/1829	27/0.76	215/98
CAB-242472-R-SB-P	1753	24/610	24/610	72/1829	27/0.76	215/98
CAB-243072-SB-P	1793	30/762	24/610	72/1829	33/0.93	225/102
CAB-243672-SB-P	1828	36/914	24/610	72/1829	39/1.10	237/108



Locking vertical storage cabinet with four adjustable shelves. Grommet included on 24in depth units.

P - Specify pull handle style

66H CAB-202466-L-VS-P	1519	24/610	20/508	66/1676	20/0.57	200/91
CAB-202466-R-VS-P	1519	24/610	20/508	66/1676	20/0.57	200/91
CAB-203066-VS-P	1559	30/762	20/508	66/1676	25/0.71	210/95
66H CAB-203666-VS-P	1608	36/914	20/508	66/1676	30/0.85	220/100
CAB-242466-L-VS-P	1637	24/610	24/610	66/1676	24/0.68	212/96
CAB-242466-R-VS-P	1637	24/610	24/610	66/1676	24/0.68	212/96
CAB-243066-VS-P	1678	30/762	24/610	66/1676	30/0.85	222/101
CAB-243666-VS-P	1775	36/914	24/610	66/1676	36/1.02	232/105
72H CAB-202472-L-VS-P	1674	24/610	20/508	72/1829	22/0.62	211/96
CAB-202472-R-VS-P	1674	24/610	20/508	72/1829	22/0.62	211/96
CAB-203072-VS-P	1714	30/762	20/508	72/1829	28/0.79	221/100
72H CAB-203672-VS-P	1766	36/914	20/508	72/1829	33/0.93	232/105
CAB-242472-L-VS-P	1805	24/610	24/610	72/1829	27/0.76	224/102
CAB-242472-R-VS-P	1805	24/610	24/610	72/1829	27/0.76	224/102
CAB-243072-VS-P	1844	30/762	24/610	72/1829	33/0.93	234/106
CAB-243672-VS-P	1951	36/914	24/610	72/1829	39/1.10	246/112

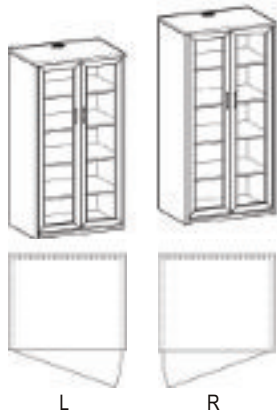

Vertical storage with non locking glazed doors and four adj. shelves. Grommet included on 24D units.

P - Specify pull handle style

Z - Specify door frame colour  
 SZ = Silver frame  
 BZ = Black frame  
 WZ = White frame

66H CAB-202466-L-VS-Z-P	2580	24/610	20/508	66/1676	20/0.57	200/91
CAB-202466-R-VS-Z-P	2580	24/610	20/508	66/1676	20/0.57	200/91
CAB-203066-VS-Z-P	2620	30/762	20/508	66/1676	25/0.71	210/95
66H CAB-203666-VS-Z-P	2652	36/914	20/508	66/1676	30/0.85	220/100
CAB-242466-L-VS-Z-P	2616	24/610	24/610	66/1676	24/0.68	212/96
CAB-242466-R-VS-Z-P	2616	24/610	24/610	66/1676	24/0.68	212/96
CAB-243066-VS-Z-P	2656	30/762	24/610	66/1676	30/0.85	222/101
CAB-243666-VS-Z-P	2690	36/914	24/610	66/1676	36/1.02	232/105
72H CAB-202472-L-VS-Z-P	2840	24/610	20/508	72/1829	22/0.62	211/96
CAB-202472-R-VS-Z-P	2840	24/610	20/508	72/1829	22/0.62	211/96
CAB-203072-VS-Z-P	2881	30/762	20/508	72/1829	28/0.79	221/100
72H CAB-203672-VS-Z-P	2916	36/914	20/508	72/1829	33/0.93	232/105
CAB-242472-L-VS-Z-P	2882	24/610	24/610	72/1829	27/0.76	224/102
CAB-242472-R-VS-Z-P	2882	24/610	24/610	72/1829	27/0.76	224/102
CAB-243072-VS-Z-P	2922	30/762	24/610	72/1829	33/0.93	234/106
CAB-243672-VS-Z-P	2958	36/914	24/610	72/1829	39/1.10	246/112

Please note: cabinet door, shelves and lateral file drawer fronts are colour matched to top colour, unless otherwise specified. For additional specification instructions and pull handle options see pages 6-7.





Vertical lateral file storage cabinet. Locking three drawer lateral file, locking doors. Mechanical interlock allows only one drawer to open at a time. One adjustable shelf in storage cabinet. Grommet included on 24in depth units.

P  - Specify pull handle style

CODE	PRICE	WIDTH (in/mm)	DEPTH (in/mm)	HEIGHT (in/mm)	VOLUME (ft3/m3)	WEIGHT (lbs/kg)	
66H	CAB-202466-L-3LSC-P	2335	24/610	20/508	66/1676	20/0.57 274/124	
	CAB-202466-R-3LSC-P	2335	24/610	20/508	66/1676	20/0.57 274/124	
	CAB-203066-3LSC-P	2376	30/762	20/508	66/1676	25/0.71 284/129	
	CAB-203666-3LSC-P	2394	36/914	20/508	66/1676	30/0.85 294/133	
	CAB-242466-L-3LSC-P	2369	24/610	24/610	66/1676	24/0.68 286/130	
	CAB-242466-R-3LSC-P	2369	24/610	24/610	66/1676	24/0.68 286/130	
	CAB-243066-3LSC-P	2408	30/762	24/610	66/1676	30/0.85 296/134	
	CAB-243666-3LSC-P	2426	36/914	24/610	66/1676	36/1.02 306/139	
	72H	CAB-202472-L-3LSC-P	2574	24/610	20/508	72/1829	22/0.62 285/129
		CAB-202472-R-3LSC-P	2574	24/610	20/508	72/1829	22/0.62 285/129
CAB-203072-3LSC-P		2615	30/762	20/508	72/1829	28/0.79 295/134	
CAB-203672-3LSC-P		2632	36/914	20/508	72/1829	33/0.93 306/139	
CAB-242472-L-3LSC-P		2611	24/610	24/610	72/1829	27/0.76 298/135	
CAB-242472-R-3LSC-P		2611	24/610	24/610	72/1829	27/0.76 298/135	
CAB-243072-3LSC-P		2651	30/762	24/610	72/1829	33/0.93 308/140	
CAB-243672-3LSC-P		2669	36/914	24/610	72/1829	39/1.10 320/145	



Vertical lateral file storage cabinet. Locking two drawer lateral file. Locking storage cabinet with two adjustable shelves. Grommet included on 24in depth units.

P  - Specify pull handle style

66H	CAB-202466-L-LS-P	1830	24/610	20/508	66/1676	20/0.57 243/110
	CAB-202466-R-LS-P	1830	24/610	20/508	66/1676	20/0.57 243/110
	CAB-203066-LS-P	1870	30/762	20/508	66/1676	25/0.71 253/115
	CAB-203666-LS-P	1903	36/914	20/508	66/1676	30/0.85 263/119
	CAB-242466-L-LS-P	1866	24/610	24/610	66/1676	24/0.68 255/116
	CAB-242466-R-LS-P	1866	24/610	24/610	66/1676	24/0.68 255/116
	CAB-243066-LS-P	1906	30/762	24/610	66/1676	30/0.85 265/120
	CAB-243666-LS-P	1938	36/914	24/610	66/1676	36/1.02 275/125
72H	CAB-202472-L-LS-P	2017	24/610	20/508	72/1829	22/0.62 254/115
	CAB-202472-R-LS-P	2017	24/610	20/508	72/1829	22/0.62 254/115
	CAB-203072-LS-P	2057	30/762	20/508	72/1829	28/0.79 264/120
	CAB-203672-LS-P	2093	36/914	20/508	72/1829	33/0.93 275/125
	CAB-242472-L-LS-P	2058	24/610	24/610	72/1829	27/0.76 267/121
	CAB-242472-R-LS-P	2058	24/610	24/610	72/1829	27/0.76 267/121
	CAB-243072-LS-P	2099	30/762	24/610	72/1829	33/0.93 277/126
	CAB-243672-LS-P	2134	36/914	24/610	72/1829	39/1.10 289/131



Locking wardrobe cabinet with one shelf and one coat rod. Grommet included on 24in depth units.

P  - Specify pull handle style

66H	CAB-202466-L-WR-P	1519	24/610	20/508	66/1676	20/0.57 173/78
	CAB-202466-R-WR-P	1519	24/610	20/508	66/1676	20/0.57 173/78
	CAB-203066-WR-P	1559	30/762	20/508	66/1676	25/0.71 183/83
	CAB-203666-WR-P	1608	36/914	20/508	66/1676	30/0.85 193/88
	CAB-242466-L-WR-P	1637	24/610	24/610	66/1676	24/0.68 185/84
	CAB-242466-R-WR-P	1637	24/610	24/610	66/1676	24/0.68 185/84
	CAB-243066-WR-P	1678	30/762	24/610	66/1676	30/0.85 195/88
	CAB-243666-WR-P	1775	36/914	24/610	66/1676	36/1.02 205/93
72H	CAB-202472-L-WR-P	1674	24/610	20/508	72/1829	22/0.62 184/83
	CAB-202472-R-WR-P	1674	24/610	20/508	72/1829	22/0.62 184/83
	CAB-203072-WR-P	1714	30/762	20/508	72/1829	28/0.79 194/88
	CAB-203672-WR-P	1766	36/914	20/508	72/1829	33/0.93 205/93
	CAB-242472-L-WR-P	1805	24/610	24/610	72/1829	27/0.76 197/89
	CAB-242472-R-WR-P	1805	24/610	24/610	72/1829	27/0.76 197/89
	CAB-243072-WR-P	1844	30/762	24/610	72/1829	33/0.93 207/94
	CAB-243672-WR-P	1951	36/914	24/610	72/1829	39/1.10 219/99

Please note: cabinet door, shelves and lateral file drawer fronts are colour matched to top colour, unless otherwise specified. For additional specification instructions and pull handle options see pages 6-7.





Vertical lateral file storage cabinet. Locking 3 drawer lateral file, non-locking glazed doors. Mechanical interlock allows only one drawer to open at a time. One adj. shelf in storage cabinet. Grommet included on 24" depth units.

P - Specify pull handle style

Z - Specify door frame colour  
SZ = Silver frame  
BZ = Black frame  
WZ = White frame

CODE	PRICE	WIDTH (in/mm)	DEPTH (in/mm)	HEIGHT (in/mm)	VOLUME (ft3/m3)	WEIGHT (lbs/kg)
66H	CAB-202466-L-3L-Z-P	2874	24/610	20/508	66/1676	20/0.57 274/124
	CAB-202466-R-3L-Z-P	2874	24/610	20/508	66/1676	20/0.57 274/124
	CAB-203066-3L-Z-P	2912	30/762	20/508	66/1676	25/0.71 284/129
	CAB-203666-3L-Z-P	2928	36/914	20/508	66/1676	30/0.85 294/133
	CAB-242466-L-3L-Z-P	2905	24/610	24/610	66/1676	24/0.68 286/130
	CAB-242466-R-3L-Z-P	2905	24/610	24/610	66/1676	24/0.68 286/130
	CAB-243066-3L-Z-P	2945	30/762	24/610	66/1676	30/0.85 296/134
	CAB-243666-3L-Z-P	2963	36/914	24/610	66/1676	36/1.02 306/139
72H	CAB-202472-L-3L-Z-P	3162	24/610	20/508	72/1829	22/0.62 285/129
	CAB-202472-R-3L-Z-P	3162	24/610	20/508	72/1829	22/0.62 285/129
	CAB-203072-3L-Z-P	3203	30/762	20/508	72/1829	28/0.79 295/134
	CAB-203672-3L-Z-P	3222	36/914	20/508	72/1829	33/0.93 306/139
	CAB-242472-L-3L-Z-P	3200	24/610	24/610	72/1829	27/0.76 298/135
	CAB-242472-R-3L-Z-P	3200	24/610	24/610	72/1829	27/0.76 298/135
	CAB-243072-3L-Z-P	3240	30/762	24/610	72/1829	33/0.93 308/140
	CAB-243672-3L-Z-P	3257	36/914	24/610	72/1829	39/1.10 320/145



Vertical lateral file storage cabinet. Locking two drawer lateral file. Non-locking glazed door storage cabinet with two adjustable shelves. Grommet included on 24in depth units.

P - Specify pull handle style

Z - Specify door frame colour  
SZ = Silver frame  
BZ = Black frame  
WZ = White frame

66H	CAB-202466-L-LS-Z-P	2398	24/610	20/508	66/1676	20/0.57 243/110
	CAB-202466-R-LS-Z-P	2398	24/610	20/508	66/1676	20/0.57 243/110
	CAB-203066-LS-Z-P	2437	30/762	20/508	66/1676	25/0.71 253/115
	CAB-203666-LS-Z-P	2472	36/914	20/508	66/1676	30/0.85 263/119
	CAB-242466-L-LS-Z-P	2434	24/610	24/610	66/1676	24/0.68 255/116
	CAB-242466-R-LS-Z-P	2434	24/610	24/610	66/1676	24/0.68 255/116
	CAB-243066-LS-Z-P	2474	30/762	24/610	66/1676	30/0.85 265/120
	CAB-243666-LS-Z-P	2506	36/914	24/610	66/1676	36/1.02 275/125
72H	CAB-202472-L-LS-Z-P	2642	24/610	20/508	72/1829	22/0.62 254/115
	CAB-202472-R-LS-Z-P	2642	24/610	20/508	72/1829	22/0.62 254/115
	CAB-203072-LS-Z-P	2681	30/762	20/508	72/1829	28/0.79 264/120
	CAB-203672-LS-Z-P	2718	36/914	20/508	72/1829	33/0.93 275/125
	CAB-242472-L-LS-Z-P	2680	24/610	24/610	72/1829	27/0.76 267/121
	CAB-242472-R-LS-Z-P	2680	24/610	24/610	72/1829	27/0.76 267/121
	CAB-243072-LS-Z-P	2720	30/762	24/610	72/1829	33/0.93 277/126
	CAB-243672-LS-Z-P	2755	36/914	24/610	72/1829	39/1.10 289/131

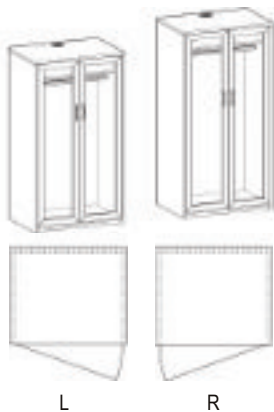

Wardrobe cabinet with non-locking glazed doors, one shelf and one coat rod. Grommet included on 24in depth units.

P - Specify pull handle style

Z - Specify door frame colour  
SZ = Silver frame  
BZ = Black frame  
WZ = White frame

66H	CAB-202466-L-WR-Z-P	2580	24/610	20/508	66/1676	20/0.57 173/78
	CAB-202466-R-WR-Z-P	2580	24/610	20/508	66/1676	20/0.57 173/78
	CAB-203066-WR-Z-P	2620	30/762	20/508	66/1676	25/0.71 183/83
	CAB-203666-WR-Z-P	2652	36/914	20/508	66/1676	30/0.85 193/88
	CAB-242466-L-WR-Z-P	2616	24/610	24/610	66/1676	24/0.68 185/84
	CAB-242466-R-WR-Z-P	2616	24/610	24/610	66/1676	24/0.68 185/84
	CAB-243066-WR-Z-P	2656	30/762	24/610	66/1676	30/0.85 195/88
	CAB-243666-WR-Z-P	2690	36/914	24/610	66/1676	36/1.02 205/93
72H	CAB-202472-L-WR-Z-P	2840	24/610	20/508	72/1829	22/0.62 184/83
	CAB-202472-R-WR-Z-P	2840	24/610	20/508	72/1829	22/0.62 184/83
	CAB-203072-WR-Z-P	2881	30/762	20/508	72/1829	28/0.79 194/88
	CAB-203672-WR-Z-P	2916	36/914	20/508	72/1829	33/0.93 205/93
	CAB-242472-L-WR-Z-P	2881	24/610	24/610	72/1829	27/0.76 197/89
	CAB-242472-R-WR-Z-P	2881	24/610	24/610	72/1829	27/0.76 197/89
	CAB-243072-WR-Z-P	2921	30/762	24/610	72/1829	33/0.93 207/94
	CAB-243672-WR-Z-P	2956	36/914	24/610	72/1829	39/1.10 219/99

Please note: cabinet door, shelves and lateral file drawer fronts are colour matched to top colour, unless otherwise specified. For additional specification instructions and pull handle options see pages 6-7.



Locking personal wardrobe storage cabinet. Four adjustable shelves in storage cabinet. One garment rod in wardrobe. Grommet included on 24in depth units.

P - Specify pull handle style

CODE	PRICE	WIDTH (in/mm)	DEPTH (in/mm)	HEIGHT (in/mm)	VOLUME (ft3/m3)	WEIGHT (lbs/kg)
66H	CAB-203066-WS-P	2232	30/762	20/508	66/1676	25/0.71 210/95
	CAB-203666-WS-P	2264	36/914	20/508	66/1676	30/0.85 220/100
	CAB-243066-WS-P	2311	30/762	24/610	66/1676	30/0.85 222/101
	CAB-243666-WS-P	2346	36/914	24/610	66/1676	36/1.02 232/105
72H	CAB-203072-WS-P	2453	30/762	20/508	72/1829	28/0.79 224/102
	CAB-203672-WS-P	2488	36/914	20/508	72/1829	33/0.93 232/105
	CAB-243072-WS-P	2544	30/762	24/610	72/1829	33/0.93 238/108
	CAB-243672-WS-P	2580	36/914	24/610	72/1829	39/1.10 246/112



Personal wardrobe storage cabinet with non-locking glazed doors. Four adjustable shelves in storage cabinet. One garment rod in wardrobe. Grommet included on 24in depth units.

P - Specify pull handle style

Z - Specify door frame colour  
SZ = Silver frame  
BZ = Black frame  
WZ = White frame

66H	CAB-203666-WS-Z-P	3194	36/914	20/508	66/1676	30/0.85 220/100
	CAB-243666-WS-Z-P	3230	36/914	24/610	66/1676	36/1.02 232/105
72H	CAB-203672-WS-Z-P	3514	36/914	20/508	72/1829	33/0.93 232/105
	CAB-243672-WS-Z-P	3553	36/914	24/610	72/1829	39/1.10 246/112

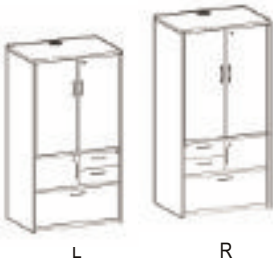

Multifunctional storage cabinet. Locking multifunction cabinet with left or right storage, 2 box drawers, and 1 lateral file. Locking storage with two adjustable shelves. Grommet included on 24in depth units.

P - Specify pull handle style

66H	CAB-203066-L-FS-P	2222	30/762	20/508	66/1676	25/0.71 253/115
	CAB-203066-R-FS-P	2222	30/762	20/508	66/1676	25/0.71 253/115
	CAB-203666-L-FS-P	2260	36/914	20/508	66/1676	30/0.85 263/119
	CAB-203666-R-FS-P	2260	36/914	20/508	66/1676	30/0.85 263/119
	CAB-243066-L-FS-P	2261	30/762	24/610	66/1676	30/0.85 265/120
	CAB-243066-R-FS-P	2261	30/762	24/610	66/1676	30/0.85 265/120
	CAB-243666-L-FS-P	2293	36/914	24/610	66/1676	36/1.02 275/125
	CAB-243666-R-FS-P	2293	36/914	24/610	66/1676	36/1.02 275/125
72H	CAB-203072-L-FS-P	2411	30/762	20/508	72/1829	28/0.79 264/120
	CAB-203072-R-FS-P	2411	30/762	20/508	72/1829	28/0.79 264/120
	CAB-203672-L-FS-P	2447	36/914	20/508	72/1829	33/0.93 275/125
	CAB-203672-R-FS-P	2447	36/914	20/508	72/1829	33/0.93 275/125
	CAB-243072-L-FS-P	2452	30/762	24/610	72/1829	33/0.93 277/126
	CAB-243072-R-FS-P	2452	30/762	24/610	72/1829	33/0.93 277/126
72H	CAB-243672-L-FS-P	2488	36/914	24/610	72/1829	39/1.10 289/131
	CAB-243672-R-FS-P	2488	36/914	24/610	72/1829	39/1.10 289/131

Please note: cabinet door, shelves and lateral file drawer fronts are colour matched to top colour, unless otherwise specified. For additional specification instructions and pull handle options see pages 6-7.







Wardrobe, Personal Storage Tower.  
Left hinge wardrobe with coat rack, locking right hinge storage cabinet with 2 adjustable shelves, two locking box drawers, one locking file drawer.

P - Specify pull handle style

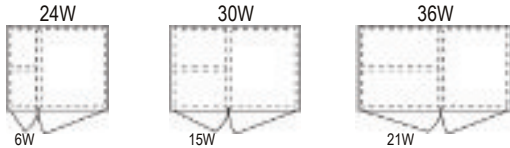

CODE	PRICE	WIDTH (in/mm)	DEPTH (in/mm)	HEIGHT (in/mm)	VOLUME (ft3/m3)	WEIGHT (lbs/kg)
66H	CAB-2066-PT-L-BBF-P	1889	24/610	20/508	66/1676	20/0.57 198/90
	CAB-203066-PT-L-BBF-P	1984	30/762	20/508	66/1676	25/0.71 208/94
	CAB-203666-PT-L-BBF-P	2077	36/914	20/508	66/1676	30/0.85 218/99
	CAB-2466-PT-L-BBF-P	1938	24/610	24/610	66/1676	24/0.68 210/95
	CAB-243066-PT-L-BBF-P	2036	30/762	24/610	66/1676	30/0.85 220/100
	CAB-243666-PT-L-BBF-P	2132	36/914	24/610	66/1676	36/1.02 230/104
72H	CAB-2072-PT-L-BBF-P	2078	24/610	20/508	72/1829	22/0.62 208/94
	CAB-203072-PT-L-BBF-P	2184	30/762	20/508	72/1829	28/0.79 218/99
	CAB-203672-PT-L-BBF-P	2287	36/914	20/508	72/1829	33/0.93 228/103
	CAB-2472-PT-L-BBF-P	2132	24/610	24/610	72/1829	27/0.76 221/100
	CAB-243072-PT-L-BBF-P	2239	30/762	24/610	72/1829	33/0.93 231/105
	CAB-243672-PT-L-BBF-P	2346	36/914	24/610	72/1829	39/1.10 241/109



Wardrobe, Personal Storage Tower.  
Left hinge wardrobe with coat rack, locking right hinge door storage cabinet with 2 adjustable shelves, two locking file drawers.

P - Specify pull handle style

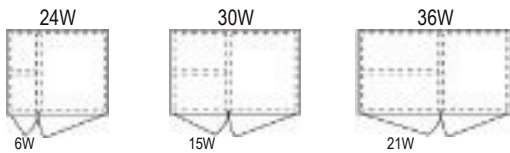

CODE	PRICE	WIDTH (in/mm)	DEPTH (in/mm)	HEIGHT (in/mm)	VOLUME (ft3/m3)	WEIGHT (lbs/kg)
66H	CAB-2066-PT-L-FF-P	1889	24/610	20/508	66/1676	20/0.57 199/90
	CAB-203066-PT-L-FF-P	1984	30/762	20/508	66/1676	25/0.71 209/95
	CAB-203666-PT-L-FF-P	2077	36/914	20/508	66/1676	30/0.85 219/99
	CAB-2466-PT-L-FF-P	1938	24/610	24/610	66/1676	24/0.68 211/96
	CAB-243066-PT-L-FF-P	2036	30/762	24/610	66/1676	30/0.85 221/100
	CAB-243666-PT-L-FF-P	2132	36/914	24/610	66/1676	36/1.02 231/105
72H	CAB-2072-PT-L-FF-P	2078	24/610	20/508	72/1829	22/0.62 208/94
	CAB-203072-PT-L-FF-P	2184	30/762	20/508	72/1829	28/0.79 218/99
	CAB-203672-PT-L-FF-P	2287	36/914	20/508	72/1829	33/0.93 228/103
	CAB-2472-PT-L-FF-P	2132	24/610	24/610	72/1829	27/0.76 221/100
	CAB-243072-PT-L-FF-P	2239	30/762	24/610	72/1829	33/0.93 231/105
	CAB-243672-PT-L-FF-P	2346	36/914	24/610	72/1829	39/1.10 241/109



Wardrobe, Personal Storage Tower.  
Left hinge wardrobe with coat rack, locking right hinge door storage cabinet with one adjustable shelf, three locking file drawers.

P - Specify pull handle style

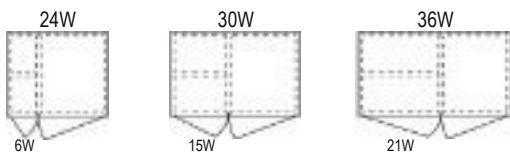

CODE	PRICE	WIDTH (in/mm)	DEPTH (in/mm)	HEIGHT (in/mm)	VOLUME (ft3/m3)	WEIGHT (lbs/kg)
66H	CAB-2066-PT-L-3F-P	2052	24/610	20/508	66/1676	20/0.57 199/90
	CAB-203066-PT-L-3F-P	2144	30/762	20/508	66/1676	25/0.71 209/95
	CAB-203666-PT-L-3F-P	2240	36/914	20/508	66/1676	30/0.85 219/99
	CAB-2466-PT-L-3F-P	2101	24/610	24/610	66/1676	24/0.68 211/96
	CAB-243066-PT-L-3F-P	2200	30/762	24/610	66/1676	30/0.85 221/100
	CAB-243666-PT-L-3F-P	2315	36/914	24/610	66/1676	36/1.02 231/105
72H	CAB-2072-PT-L-3F-P	2255	24/610	20/508	72/1829	22/0.62 216/98
	CAB-203072-PT-L-3F-P	2360	30/762	20/508	72/1829	28/0.79 226/103
	CAB-203672-PT-L-3F-P	2464	36/914	20/508	72/1829	33/0.93 236/107
	CAB-2472-PT-L-3F-P	2311	24/610	24/610	72/1829	27/0.76 229/104
	CAB-243072-PT-L-3F-P	2418	30/762	24/610	72/1829	33/0.93 239/108
	CAB-243672-PT-L-3F-P	2525	36/914	24/610	72/1829	39/1.10 249/113



Wardrobe, Personal Storage Tower.  
Left hinge wardrobe with coat rack, locking right hinge door storage cabinet with four adjustable shelves.

P - Specify pull handle style

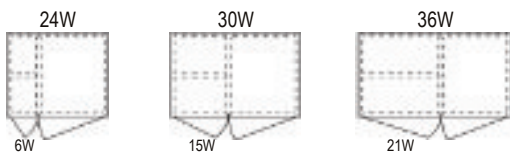

CODE	PRICE	WIDTH (in/mm)	DEPTH (in/mm)	HEIGHT (in/mm)	VOLUME (ft3/m3)	WEIGHT (lbs/kg)
66H	CAB-2066-PT-L-WS-P	1889	24/610	20/508	66/1676	20/0.57 179/81
	CAB-203066-PT-L-WS-P	1984	30/762	20/508	66/1676	25/0.71 189/86
	CAB-203666-PT-L-WS-P	2077	36/914	20/508	66/1676	30/0.85 199/90
	CAB-2466-PT-L-WS-P	1938	24/610	24/610	66/1676	24/0.68 191/87
	CAB-243066-PT-L-WS-P	2036	30/762	24/610	66/1676	30/0.85 201/91
	CAB-243666-PT-L-WS-P	2132	36/914	24/610	66/1676	36/1.02 211/96
72H	CAB-2072-PT-L-WS-P	2078	24/610	20/508	72/1829	22/0.62 189/86
	CAB-203072-PT-L-WS-P	2184	30/762	20/508	72/1829	28/0.79 199/90
	CAB-203672-PT-L-WS-P	2287	36/914	20/508	72/1829	33/0.93 209/95
	CAB-2472-PT-L-WS-P	2132	24/610	24/610	72/1829	27/0.76 202/92
	CAB-243072-PT-L-WS-P	2239	30/762	24/610	72/1829	33/0.93 212/96
	CAB-243672-PT-L-WS-P	2346	36/914	24/610	72/1829	39/1.10 222/101

Please note: cabinet door, shelves and lateral file drawer fronts are colour matched to top colour, unless otherwise specified. For additional specification instructions and pull handle options see pages 6-7.



Wardrobe, Personal Storage Tower.  
Right hinge wardrobe with coat rack, locking left hinge storage cabinet with 2 adjustable shelves, two locking box drawers, one locking file drawer.

P - Specify pull handle style

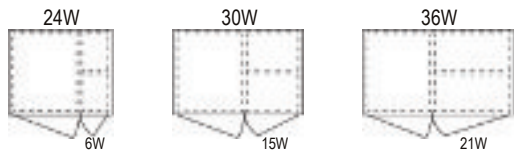

CODE	PRICE	WIDTH (in/mm)	DEPTH (in/mm)	HEIGHT (in/mm)	VOLUME (ft3/m3)	WEIGHT (lbs/kg)
66H CAB-2066-PT-R-BBF-P	1889	24/610	20/508	66/1676	20/0.57	198/90
CAB-203066-PT-R-BBF-P	1984	30/762	20/508	66/1676	25/0.71	208/94
CAB-203666-PT-R-BBF-P	2077	36/914	20/508	66/1676	30/0.85	218/99
CAB-2466-PT-R-BBF-P	1938	24/610	24/610	66/1676	24/0.68	210/95
CAB-243066-PT-R-BBF-P	2036	30/762	24/610	66/1676	30/0.85	220/100
CAB-243666-PT-R-BBF-P	2132	36/914	24/610	66/1676	36/1.02	230/104
72H CAB-2072-PT-R-BBF-P	2078	24/610	20/508	72/1829	22/0.62	208/94
CAB-203072-PT-R-BBF-P	2184	30/762	20/508	72/1829	28/0.79	218/99
CAB-203672-PT-R-BBF-P	2287	36/914	20/508	72/1829	33/0.93	228/103
CAB-2472-PT-R-BBF-P	2132	24/610	24/610	72/1829	27/0.76	221/100
CAB-243072-PT-R-BBF-P	2239	30/762	24/610	72/1829	33/0.93	231/105
CAB-243672-PT-R-BBF-P	2346	36/914	24/610	72/1829	39/1.10	241/109



Wardrobe, Personal Storage Tower.  
Right hinge wardrobe with coat rack, locking left hinge door storage cabinet with 2 adjustable shelves, two locking file drawers.

P - Specify pull handle style

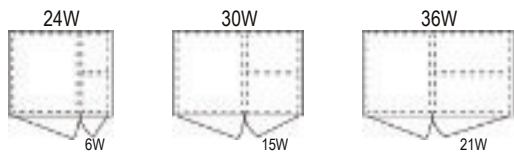

66H CAB-2066-PT-R-FF-P	1889	24/610	20/508	66/1676	20/0.57	199/90
CAB-203066-PT-R-FF-P	1984	30/762	20/508	66/1676	25/0.71	209/95
CAB-203666-PT-R-FF-P	2077	36/914	20/508	66/1676	30/0.85	219/99
CAB-2466-PT-R-FF-P	1938	24/610	24/610	66/1676	24/0.68	211/96
CAB-243066-PT-R-FF-P	2036	30/762	24/610	66/1676	30/0.85	221/100
CAB-243666-PT-R-FF-P	2132	36/914	24/610	66/1676	36/1.02	231/105
72H CAB-2072-PT-R-FF-P	2078	24/610	20/508	72/1829	22/0.62	208/94
CAB-203072-PT-R-FF-P	2184	30/762	20/508	72/1829	28/0.79	218/99
CAB-203672-PT-R-FF-P	2287	36/914	20/508	72/1829	33/0.93	228/103
CAB-2472-PT-R-FF-P	2132	24/610	24/610	72/1829	27/0.76	221/100
CAB-243072-PT-R-FF-P	2239	30/762	24/610	72/1829	33/0.93	231/105
CAB-243672-PT-R-FF-P	2346	36/914	24/610	72/1829	39/1.10	241/109



Wardrobe, Personal Storage Tower.  
Right hinge wardrobe with coat rack, locking left hinge door storage cabinet with one adjustable shelf, three locking file drawers.

P - Specify pull handle style

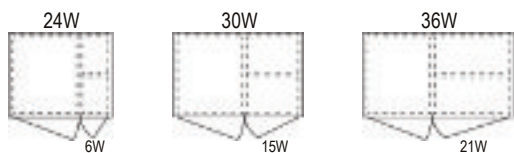

66H CAB-2066-PT-R-3F-P	2052	24/610	20/508	66/1676	20/0.57	199/90
CAB-203066-PT-R-3F-P	2144	30/762	20/508	66/1676	25/0.71	209/95
CAB-203666-PT-R-3F-P	2240	36/914	20/508	66/1676	30/0.85	219/99
CAB-2466-PT-R-3F-P	2101	24/610	24/610	66/1676	24/0.68	211/96
CAB-243066-PT-R-3F-P	2200	30/762	24/610	66/1676	30/0.85	221/100
CAB-243666-PT-R-3F-P	2315	36/914	24/610	66/1676	36/1.02	231/105
72H CAB-2072-PT-R-3F-P	2255	24/610	20/508	72/1829	22/0.62	216/98
CAB-203072-PT-R-3F-P	2360	30/762	20/508	72/1829	28/0.79	226/103
CAB-203672-PT-R-3F-P	2464	36/914	20/508	72/1829	33/0.93	236/107
CAB-2472-PT-R-3F-P	2311	24/610	24/610	72/1829	27/0.76	229/104
CAB-243072-PT-R-3F-P	2418	30/762	24/610	72/1829	33/0.93	239/108
CAB-243672-PT-R-3F-P	2525	36/914	24/610	72/1829	39/1.10	249/113



Wardrobe, Personal Storage Tower.  
Right hinge wardrobe with coat rack, locking left hinge door storage cabinet with four adjustable shelves.

P - Specify pull handle style

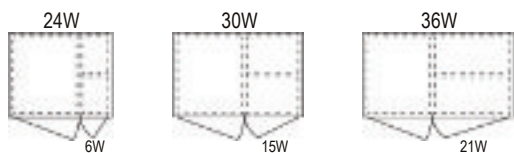

66H CAB-2066-PT-R-WS-P	1889	24/610	20/508	66/1676	20/0.57	179/81
CAB-203066-PT-R-WS-P	1984	30/762	20/508	66/1676	25/0.71	189/86
CAB-203666-PT-R-WS-P	2077	36/914	20/508	66/1676	30/0.85	199/90
CAB-2466-PT-R-WS-P	1938	24/610	24/610	66/1676	24/0.68	191/87
CAB-243066-PT-R-WS-P	2036	30/762	24/610	66/1676	30/0.85	201/91
CAB-243666-PT-R-WS-P	2132	36/914	24/610	66/1676	36/1.02	211/96
72H CAB-2072-PT-R-WS-P	2078	24/610	20/508	72/1829	22/0.62	189/86
CAB-203072-PT-R-WS-P	2184	30/762	20/508	72/1829	28/0.79	199/90
CAB-203672-PT-R-WS-P	2287	36/914	20/508	72/1829	33/0.93	209/95
CAB-2472-PT-R-WS-P	2132	24/610	24/610	72/1829	27/0.76	202/92
CAB-243072-PT-R-WS-P	2239	30/762	24/610	72/1829	33/0.93	212/96
CAB-243672-PT-R-WS-P	2346	36/914	24/610	72/1829	39/1.10	222/101

Please note: cabinet door, shelves and lateral file drawer fronts are colour matched to top colour, unless otherwise specified.  
For additional specification instructions and pull handle options see pages 6-7.





Wardrobe, Personal Storage Tower. Left hinge wardrobe with coat rack, non-locking right hinge glazed door storage cabinet with 2 adjustable shelves, two locking box drawers, one locking file drawer.

P - Specify pull handle style

CODE	PRICE	WIDTH (in/mm)	DEPTH (in/mm)	HEIGHT (in/mm)	VOLUME (ft <sup>3</sup> /m <sup>3</sup> )	WEIGHT (lbs/kg)
------	-------	------------------	------------------	-------------------	--	--------------------

66H	CAB-2066-PT-L-BBF- <b>Z</b> -P	2561	24/610	20/508	66/1676	20/0.57	198/90
	CAB-2466-PT-L-BBF- <b>Z</b> -P	2599	24/610	24/610	66/1676	24/0.68	210/95
72H	CAB-2072-PT-L-BBF- <b>Z</b> -P	2820	24/610	20/508	72/1829	22/0.62	208/94
	CAB-2472-PT-L-BBF- <b>Z</b> -P	2858	24/610	24/610	72/1829	27/0.76	221/100

**Z** - Specify door frame colour  
SZ = Silver frame      BZ = Black frame      WZ = White frame



Wardrobe, Personal Storage Tower. Left hinge wardrobe with coat rack, non-locking right hinge glazed door storage cabinet with 2 adjustable shelves, two locking file drawers.

P - Specify pull handle style

66H	CAB-2066-PT-L-FF- <b>Z</b> -P	2561	24/610	20/508	66/1676	20/0.57	199/90
	CAB-2466-PT-L-FF- <b>Z</b> -P	2599	24/610	24/610	66/1676	24/0.68	211/96
72H	CAB-2072-PT-L-FF- <b>Z</b> -P	2820	24/610	20/508	72/1829	22/0.62	208/94
	CAB-2472-PT-L-FF- <b>Z</b> -P	2858	24/610	24/610	72/1829	27/0.76	221/100

**Z** - Specify door frame colour  
SZ = Silver frame      BZ = Black frame      WZ = White frame



Wardrobe, Personal Storage Tower. Left hinge wardrobe with coat rack, non-locking right hinge glazed door storage cabinet with one adjustable shelf, three locking file drawers.

P - Specify pull handle style

66H	CAB-2066-PT-L-3F- <b>Z</b> -P	2723	24/610	20/508	66/1676	20/0.57	199/90
	CAB-2466-PT-L-3F- <b>Z</b> -P	2759	24/610	24/610	66/1676	24/0.68	211/96
72H	CAB-2072-PT-L-3F- <b>Z</b> -P	2996	24/610	20/508	72/1829	22/0.62	216/98
	CAB-2472-PT-L-3F- <b>Z</b> -P	3038	24/610	24/610	72/1829	27/0.76	229/104

**Z** - Specify door frame colour  
SZ = Silver frame      BZ = Black frame      WZ = White frame



Wardrobe, Personal Storage Tower. Left hinge wardrobe with coat rack, non-locking right hinge door storage cabinet with four adjustable shelves.

P - Specify pull handle style

66H	CAB-2066-PT-L-WS- <b>Z</b> -P	2652	24/610	20/508	66/1676	20/0.57	179/81
	CAB-2466-PT-L-WS- <b>Z</b> -P	2690	24/610	24/610	66/1676	24/0.68	191/87
72H	CAB-2072-PT-L-WS- <b>Z</b> -P	2916	24/610	20/508	72/1829	22/0.62	189/86
	CAB-2472-PT-L-WS- <b>Z</b> -P	2958	24/610	24/610	72/1829	27/0.76	202/92

**Z** - Specify door frame colour  
SZ = Silver frame      BZ = Black frame      WZ = White frame

Please note: cabinet door, shelves and lateral file drawer fronts are colour matched to top colour, unless otherwise specified. For additional specification instructions and pull handle options see pages 6-7.



Wardrobe, Personal Storage Tower. Right hinge wardrobe with coat rack, non-locking left hinge glazed door storage cabinet with 2 adjustable shelves, two locking box drawers, one locking file drawer.

P - Specify pull handle style

CODE	PRICE	WIDTH (in/mm)	DEPTH (in/mm)	HEIGHT (in/mm)	VOLUME (ft3/m3)	WEIGHT (lbs/kg)
66H CAB-2066-PT-R-BBF-Z-P	2561	24/610	20/508	66/1676	20/0.57	198/90
66H CAB-2466-PT-R-BBF-Z-P	2599	24/610	24/610	66/1676	24/0.68	210/95
72H CAB-2072-PT-R-BBF-Z-P	2820	24/610	20/508	72/1829	22/0.62	208/94
72H CAB-2472-PT-R-BBF-Z-P	2858	24/610	24/610	72/1829	27/0.76	221/100

Z - Specify door frame colour

SZ = Silver frame

BZ = Black frame

WZ = White frame



Wardrobe, Personal Storage Tower. Right hinge wardrobe with coat rack, non-locking left hinge glazed door storage cabinet with 2 adjustable shelves, two locking file drawers.

P - Specify pull handle style

66H CAB-2066-PT-R-FF-Z-P	2561	24/610	20/508	66/1676	20/0.57	199/90
66H CAB-2466-PT-R-FF-Z-P	2599	24/610	24/610	66/1676	24/0.68	211/96
72H CAB-2072-PT-R-FF-Z-P	2820	24/610	20/508	72/1829	22/0.62	208/94
72H CAB-2472-PT-R-FF-Z-P	2858	24/610	24/610	72/1829	27/0.76	221/100

Z - Specify door frame colour

SZ = Silver frame

BZ = Black frame

WZ = White frame



Wardrobe, Personal Storage Tower. Right hinge wardrobe with coat rack, non-locking left hinge glazed door storage cabinet with one adjustable shelf, three locking file drawers.

P - Specify pull handle style

66H CAB-2066-PT-R-3F-Z-P	2723	24/610	20/508	66/1676	20/0.57	199/90
66H CAB-2466-PT-R-3F-Z-P	2759	24/610	24/610	66/1676	24/0.68	211/96
72H CAB-2072-PT-R-3F-Z-P	2996	24/610	20/508	72/1829	22/0.62	216/98
72H CAB-2472-PT-R-3F-Z-P	3038	24/610	24/610	72/1829	27/0.76	229/104

Z - Specify door frame colour

SZ = Silver frame

BZ = Black frame

WZ = White frame



Wardrobe, Personal Storage Tower. Right hinge wardrobe with coat rack, non-locking left hinge door storage cabinet with four adjustable shelves.

P - Specify pull handle style

66H CAB-2066-PT-R-WS-Z-P	2652	24/610	20/508	66/1676	20/0.57	179/81
66H CAB-2466-PT-R-WS-Z-P	2690	24/610	24/610	66/1676	24/0.68	191/87
72H CAB-2072-PT-R-WS-Z-P	2916	24/610	20/508	72/1829	22/0.62	189/86
72H CAB-2472-PT-R-WS-Z-P	2958	24/610	24/610	72/1829	27/0.76	202/92







Z - Specify door frame colour

SZ = Silver frame



BZ = Black frame

WZ = White frame

Please note: cabinet door, shelves and lateral file drawer fronts are colour matched to top colour, unless otherwise specified. For additional specification instructions and pull handle options see pages 6-7.

			WIDTH	DEPTH	HEIGHT	VOLUME	WEIGHT
	CODE	PRICE	(in/mm)	(in/mm)	(in/mm)	(ft <sup>3</sup> /m <sup>3</sup> )	(lbs/kg)
 <p>Vertical storage cabinet with one 1" adjustable shelf, bookcase with two 1" adjustable shelves</p> <p>P - Specify pull handle style</p>	BKC-123672-SCBC-P	982	36/914	12/305	72/1829	20/0.57	129/59
 <p>Bookcase with one 1" adjustable shelf.</p>	BKC-122429-BC	649	24/610	12/305	29/737	7/0.20	60/27
	BKC-123029-BC	679	30/762	12/305	29/737	8/0.23	70/32
	BKC-123629-BC	712	36/914	12/305	29/737	9/0.25	80/36
 <p>Bookcase with three 1" adjustable shelves.</p>	BKC-122448-BC	683	24/610	12/305	48/1219	9/0.25	78/35
	BKC-123048-BC	714	30/762	12/305	48/1219	11/0.31	91/41
	BKC-123648-BC	746	36/914	12/305	48/1219	14/0.40	103/47
 <p>Bookcase with four 1" adjustable shelves.</p>	66H BKC-122466-BC	732	24/610	12/305	66/1676	13/0.37	102/46
	BKC-123066-BC	764	30/762	12/305	66/1676	16/0.45	119/54
	BKC-123666-BC	797	36/914	12/305	66/1676	19/0.54	135/61
	72H BKC-122472-BC	764	24/610	12/305	72/1829	14/0.40	107/49
	BKC-123072-BC	797	30/762	12/305	72/1829	17/0.48	124/56
	BKC-123672-BC	828	36/914	12/305	72/1829	20/0.57	141/64
 <p>Bookcase with five 1" adjustable shelves.</p>	BKC-122484-BC	994	24/610	12/305	84/2134	18/0.51	140/64
	BKC-123084-BC	1036	30/762	12/305	84/2134	22/0.62	161/73
	BKC-123684-BC	1075	36/914	12/305	84/2134	27/0.76	185/84
 <p>Extra 1" shelves for bookcase.</p>	BKC-24-SHELF	84	22/559	11/279	1/25		
	BKC-30-SHELF	90	28/711	11/279	1/25		
	BKC-36-SHELF	100	34/864	11/279	1/25		

All Links bookcases are manufactured with full 1" construction, 3mm edging and finished matching back.  
Please note: cabinet door, shelves and lateral file drawer fronts are colour matched to top colour, unless otherwise specified.  
For additional specification instructions and pull handle options see pages 6-7.

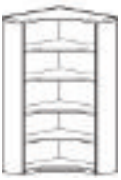
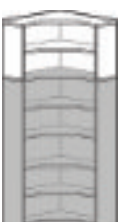
			WIDTH	DEPTH	HEIGHT	VOLUME	WEIGHT
	CODE	PRICE	(in/mm)	(in/mm)	(in/mm)	(ft <sup>3</sup> /m <sup>3</sup> )	(lbs/kg)
 <p>Vertical storage cabinet and display case. One adjustable shelf in storage cabinet, three fixed display shelves with a 1" thick black lip.</p> <p>P - Specify pull handle style</p>	BKC-123672-SCDC-P	1363	36/914	12/305	72/1829	18/0.51	120/54
 <p>Display case with four fixed display shelves with a 1" thick black lip.</p>	BKC-123672-DC	1200	36/914	12/305	72/1829	20/0.57	120/54
 <p>27"H Bookcase extension with one adjustable shelf.</p>	BKC-122427-BC-HE	500	24/610	12/305	27/686	3/0.08	72/33
	BKC-123027-BC-HE	532	30/762	12/305	27/686	3/0.08	75/34
	BKC-123627-BC-HE	565	36/914	12/305	27/686	3/0.08	78/35
 <p>Corner bookcase with four 1" adjustable shelves.</p>	BKC-123672-CBC	2182	36/914	12/305	72/1829	54/1.53	260/118
 <p>27"H Corner Bookcase extension with one adjustable shelf.</p>	BKC-123627-CBC-HE	1036	36/914	12/305	27/686	4/0.11	140/64

All Links bookcases are manufactured with full 1" construction, 3mm edging and finished matching back.  
Please note: cabinet door, shelves and lateral file drawer fronts are colour matched to top colour, unless otherwise specified.  
For additional specification instructions and pull handle options see pages 6-7.

Square Corner Bookshelf

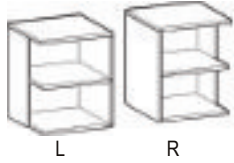

29"H Square Corner Bookshelf with one adjustable shelf. Left or right.

CODE	PRICE	WIDTH (in/mm)	DEPTH (in/mm)	HEIGHT (in/mm)	VOLUME (ft <sup>3</sup> /m <sup>3</sup> )	WEIGHT (lbs/kg)
20" BKC-2029-L-SBS	751	20/508	20/508	29/737	10/0.28	102/46
BKC-2029-R-SBS	751	20/508	20/508	29/737	10/0.28	102/46
24" BKC-2429-L-SBS	785	24/610	24/610	29/737	11/0.31	130/59
BKC-2429-R-SBS	785	24/610	24/610	29/737	11/0.31	130/59

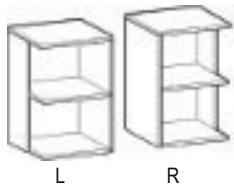

36"H Square Corner Bookshelf with one adjustable shelf. Left or right.

20" BKC-2036-L-SBS	1073	20/508	20/508	36/914	10/0.28	105/48
BKC-2036-R-SBS	1073	20/508	20/508	36/914	10/0.28	105/48
24" BKC-2436-L-SBS	1138	24/610	24/610	36/914	14/0.40	135/61
BKC-2436-R-SBS	1138	24/610	24/610	36/914	14/0.40	135/61

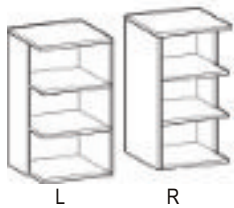

42"H Square Corner Bookshelf with two adjustable shelves. Left or right.

20" BKC-2042-L-SBS	1104	20/508	20/508	42/1067	11/0.31	108/49
BKC-2042-R-SBS	1104	20/508	20/508	42/1067	11/0.31	108/49
24" BKC-2442-L-SBS	1168	24/610	24/610	42/1067	15/0.42	140/64
BKC-2442-R-SBS	1168	24/610	24/610	42/1067	15/0.42	140/64



66"H, 72"H Square Corner Bookshelf with four adjustable shelves. Left or right.

66H BKC-2066-L-SBS	1186	20/508	20/508	66/1676	18/0.51	116/53
BKC-2066-R-SBS	1186	20/508	20/508	66/1676	18/0.51	116/53
BKC-2466-L-SBS	1218	24/610	24/610	66/1676	25/0.71	150/68
BKC-2466-R-SBS	1218	24/610	24/610	66/1676	25/0.71	150/68
72H BKC-2072-L-SBS	1307	20/508	20/508	72/1829	20/0.57	126/57
BKC-2072-R-SBS	1307	20/508	20/508	72/1829	20/0.57	126/57
BKC-2472-L-SBS	1355	24/610	24/610	72/1829	27/0.76	160/73
BKC-2472-R-SBS	1355	24/610	24/610	72/1829	27/0.76	160/73

For additional specification instructions see page 6.



Corner Bookshelf

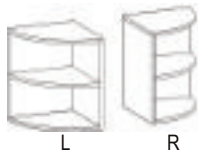

29"H Corner Bookshelf with one fixed shelf. Left or right.

CODE	PRICE	WIDTH (in/mm)	DEPTH (in/mm)	HEIGHT (in/mm)	VOLUME (ft3/m3)	WEIGHT (lbs/kg)
20" BKC-2029-L-CBS	590	20/508	20/508	29/737	10/0.28	102/46
	590	20/508	20/508	29/737	10/0.28	102/46
24" BKC-2429-L-CBS	622	24/610	24/610	29/737	11/0.31	130/59
	622	24/610	24/610	29/737	11/0.31	130/59

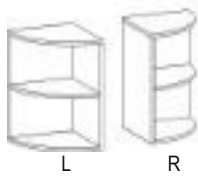

36"H Corner Bookshelf with one fixed shelf. Left or right.

20" BKC-2036-L-CBS	912	20/508	20/508	36/914	10/0.28	105/48
	912	20/508	20/508	36/914	10/0.28	105/48
24" BKC-2436-L-CBS	942	24/610	24/610	36/914	14/0.40	135/61
	942	24/610	24/610	36/914	14/0.40	135/61

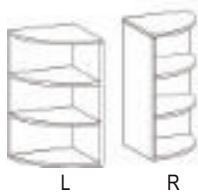

42"H Corner Bookshelf with two fixed shelves. Left or right.

20" BKC-2042-L-CBS	941	20/508	20/508	42/1067	11/0.31	108/49
	941	20/508	20/508	42/1067	11/0.31	108/49
24" BKC-2442-L-CBS	973	24/610	24/610	42/1067	15/0.42	140/64
	973	24/610	24/610	42/1067	15/0.42	140/64

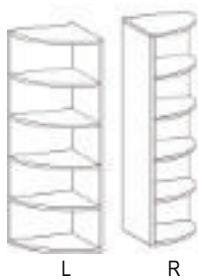

66"H, 72"H Corner Bookshelf with four fixed shelves. Left or right.

66H BKC-2066-L-CBS	1021	20/508	20/508	66/1676	18/0.51	116/53
	1021	20/508	20/508	66/1676	18/0.51	116/53
	1057	24/610	24/610	66/1676	25/0.71	150/68
	1057	24/610	24/610	66/1676	25/0.71	150/68
72H BKC-2072-L-CBS	1124	20/508	20/508	72/1829	20/0.57	126/57
	1124	20/508	20/508	72/1829	20/0.57	126/57
	1160	24/610	24/610	72/1829	27/0.76	160/73
	1160	24/610	24/610	72/1829	27/0.76	160/73



14" Corner Book Shelf (hutch) with two fixed shelves. Left or right.

36H BKC-1436-L-CBS	431	14/356	14/356	36/914	5/0.14	30/14
	431	14/356	14/356	36/914	5/0.14	30/14
42H BKC-1442-L-CBS	497	14/356	14/356	42/1067	6/0.17	40/18
	497	14/356	14/356	42/1067	6/0.17	40/18

For additional specification instructions see page 6.

Posts

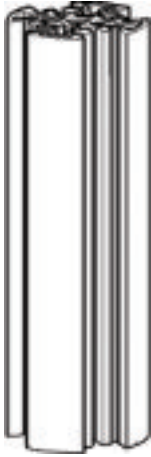

In-Links divider post with post cap included.  
Come in 6", 12", 18", 24", and 36" heights.

2 posts required for straight panel applications,  
3 posts required for corner applications.

Default post colour is Black.

For Black Post add **BK** to code  
i.e. PST-0012-BK

For Silver Post add **AL** to code  
i.e. PST-0012-AL

CODE	PRICE	WIDTH (in/mm)	DEPTH (in/mm)	HEIGHT (in/mm)	VOLUME (ft <sup>3</sup> /m <sup>3</sup> )	WEIGHT (lbs/kg)
------	-------	------------------	------------------	-------------------	--	--------------------

PST-0006-	78	2/51	dia.	6/152	1/0.03	1.0/0.5
PST-0012-	84	2/51	dia.	12/305	1/0.03	1.0/0.5
PST-0018-	90	2/51	dia.	18/457	1/0.03	1.5/0.7
PST-0024-	96	2/51	dia.	24/610	1/0.03	2.0/0.9
PST-0036-	133	2/51	dia.	36/914	1/0.03	3.0/1.4

**Worksurfaces are predrilled with anchor holes to accept divider posts.  
A drawing must be provided with your order to ensure sufficient number  
of spacers and fillers are included.**



For additional specification instructions see page 6.

CODE	PRICE					WIDTH (in/mm)	DEPTH (in/mm)	HEIGHT (in/mm)	VOLUME (ft3/m3)	WEIGHT (lbs/kg)
	(L)	(G,C,W)	(F)	(S)	(Z,X)					

**Panel Inserts**

**Panels are specified as followed:**

Specify Type:



Laminate (L)

i.e. TIL-1272-L

(see samples for finish colour selection)



Glazed (G) (smoked ribbed polycarbonate)

i.e. TIL-1272-G



Crystal (C) (crystal ribbed polycarbonate)

i.e. TIL-1272-C



Whiteboard (W)

i.e. TIL-1272-W



Fabric (F)

i.e. TIL-1272-F

(see fabric cards for available selection)



Slatwall (S) (specify finish)

Chamois Black - BK

Brushed Aluminum - AL

i.e. TIL-1272-S-AL



Frosted (Z) or Clear (X)

i.e. TIL-1272-Z or TIL-1272-X

Please Specify

- For laminate, specify finish
- For slatwall, specify finish code
- For fabric, specify fabric colour code
- Please provide drawing at time of order.

6" HIGH	TIL-0624-	161	200	226	250	295	24/610	2/51	6/152	1/0.03	1.6/0.7
	TIL-0630-	176	221	254	276	330	30/762	2/51	6/152	1/0.03	2.0/0.9
	TIL-0636-	191	239	276	302	358	36/914	2/51	6/152	1/0.03	2.5/1.1
	TIL-0642-	204	260	301	331	394	42/1067	2/51	6/152	1/0.03	2.9/1.3
	TIL-0648-	220	281	324	356	422	48/1219	2/51	6/152	1/0.03	3.3/1.5
	TIL-0654-	232	301	352	385	455	54/1372	2/51	6/152	1/0.03	3.7/1.7
	TIL-0660-	248	340	374	410	486	60/1524	2/51	6/152	1/0.03	4.1/1.9
	TIL-0666-	262	362	396	431	514	66/1676	2/51	6/152	1/0.03	4.5/2.0
TIL-0672-	276	398	428	461	559	72/1829	2/51	6/152	1/0.03	4.9/2.2	
12" HIGH	TIL-1224-	181	224	254	277	330	24/610	2/51	12/305	1/0.03	1.8/0.8
	TIL-1230-	196	246	281	310	365	30/762	2/51	12/305	1/0.03	2.2/1.0
	TIL-1236-	215	268	310	338	400	36/914	2/51	12/305	1/0.03	2.7/1.2
	TIL-1242-	228	292	337	368	425	42/1067	2/51	12/305	1/0.03	3.1/1.4
	TIL-1248-	241	314	364	398	473	48/1219	2/51	12/305	1/0.03	3.6/1.6
	TIL-1254-	261	337	391	427	509	54/1372	2/51	12/305	1/0.03	4.0/1.8
	TIL-1260-	276	356	419	455	542	60/1524	2/51	12/305	1/0.03	4.5/2.0
	TIL-1266-	295	382	450	485	586	66/1676	2/51	12/305	1/0.03	5.0/2.3
TIL-1272-	314	402	481	514	624	72/1829	2/51	12/305	1/0.03	5.5/2.5	
18" HIGH	TIL-1824-	234	368	385	N/A	502	24/610	2/51	18/457	1/0.03	2.4/1.1
	TIL-1830-	256	398	426	N/A	554	30/762	2/51	18/457	1/0.03	3.0/1.4
	TIL-1836-	276	428	466	N/A	607	36/914	2/51	18/457	1/0.03	3.7/1.7
	TIL-1842-	296	479	510	N/A	664	42/1067	2/51	18/457	1/0.03	4.3/2.0
	TIL-1848-	314	496	545	N/A	709	48/1219	2/51	18/457	1/0.03	4.9/2.2
	TIL-1854-	338	528	590	N/A	768	54/1372	2/51	18/457	1/0.03	5.5/2.5
	TIL-1860-	361	563	629	N/A	820	60/1524	2/51	18/457	1/0.03	6.1/2.8
	TIL-1866-	382	590	674	N/A	877	66/1676	2/51	18/457	1/0.03	6.7/3.0
TIL-1872-	409	620	703	N/A	917	72/1829	2/51	18/457	1/0.03	7.3/3.3	
24" HIGH	TIL-2424-	305	410	427	N/A	556	24/610	2/51	24/610	1/0.03	3.2/1.5
	TIL-2430-	332	444	478	N/A	619	30/762	2/51	24/610	1/0.03	4.0/1.8
	TIL-2436-	361	480	518	N/A	674	36/914	2/51	24/610	1/0.03	5.0/2.3
	TIL-2442-	383	534	569	N/A	739	42/1067	2/51	24/610	1/0.03	5.8/2.6
	TIL-2448-	409	552	611	N/A	791	48/1219	2/51	24/610	1/0.03	6.6/3.0
	TIL-2454-	438	586	655	N/A	851	54/1372	2/51	24/610	1/0.03	7.4/3.4
	TIL-2460-	469	620	698	N/A	907	60/1524	2/51	24/610	1/0.03	8.2/3.7
	TIL-2466-	497	664	751	N/A	978	66/1676	2/51	24/610	1/0.03	9.0/4.1
TIL-2472-	530	709	804	N/A	1044	72/1829	2/51	24/610	1/0.03	9.8/4.4	

**Panel Insert widths shown reflect size of worksurface when used with Links support posts only.**

See Links Fabric cards for available selections.

For additional specification instructions and laminate colours see pages 6-7.

Linear Panel Set



Includes: two 6"H black support posts, two black support caps, and one 6"H divider panel. All mounting hardware included.

For optional brushed aluminum posts add suffix **AL** to end of code. i.e. LPS-0648-L-AL

CODE	PRICE					WIDTH (in/mm)	DEPTH (in/mm)	HEIGHT (in/mm)	VOLUME (ft3/m3)	WEIGHT (lbs/kg)
	(L)	(G,C,W)	(F)	(S)	(Z,X)					
LPS-0624-	365	401	422	448	550	24/610	2/51	6/152	1/0.03	9/4.1
LPS-0630-	383	428	455	481	593	30/762	2/51	6/152	1/0.03	11/5.0
LPS-0636-	401	460	488	516	636	36/914	2/51	6/152	1/0.03	13/5.9
LPS-0642-	422	488	522	553	677	42/1067	2/51	6/152	1/0.03	14/6.4
LPS-0648-	442	515	553	590	720	48/1219	2/51	6/152	1/0.03	16/7.3
LPS-0654-	460	544	589	624	766	54/1372	2/51	6/152	1/0.03	17/7.7
LPS-0660-	479	572	619	660	806	60/1524	2/51	6/152	1/0.03	19/8.6
LPS-0666-	497	605	653	694	850	66/1676	2/51	6/152	1/0.03	21/9.5
LPS-0672-	515	629	688	725	892	72/1829	2/51	6/152	1/0.03	22/10.0



Includes: two 12"H black support posts, two black support caps, and one 12"H divider panel. All mounting hardware included.

For optional brushed aluminum posts add suffix **AL** to end of code. i.e. LPS-1248-L-AL

LPS-1224-	365	401	422	448	550	24/610	2/51	12/305	1/0.03	9/4.1
LPS-1230-	383	428	455	481	593	30/762	2/51	12/305	1/0.03	11/5.0
LPS-1236-	401	460	488	516	636	36/914	2/51	12/305	1/0.03	13/5.9
LPS-1242-	422	488	522	553	677	42/1067	2/51	12/305	1/0.03	14/6.4
LPS-1248-	442	515	553	590	720	48/1219	2/51	12/305	1/0.03	16/7.3
LPS-1254-	460	544	589	624	766	54/1372	2/51	12/305	1/0.03	17/7.7
LPS-1260-	479	572	619	660	806	60/1524	2/51	12/305	1/0.03	19/8.6
LPS-1266-	497	605	653	694	850	66/1676	2/51	12/305	1/0.03	21/9.5
LPS-1272-	515	629	688	725	892	72/1829	2/51	12/305	1/0.03	22/10.0



Includes: two 18"H black support posts, two black support caps, and one 18"H divider panel. All mounting hardware included.

For optional brushed aluminum posts add suffix **AL** to end of code. i.e. LPS-1848-L-AL

LPS-1824-	448	504	538	N/A	698	24/610	2/51	18/457	1/0.03	13/5.9
LPS-1830-	474	539	584	N/A	758	30/762	2/51	18/457	1/0.03	15/6.8
LPS-1836-	499	576	620	N/A	809	36/914	2/51	18/457	1/0.03	17/7.7
LPS-1842-	526	611	664	N/A	863	42/1067	2/51	18/457	1/0.03	19/8.6
LPS-1848-	550	644	706	N/A	918	48/1219	2/51	18/457	1/0.03	21/9.5
LPS-1854-	577	683	749	N/A	976	54/1372	2/51	18/457	1/0.03	23/10.4
LPS-1860-	605	719	790	N/A	1031	60/1524	2/51	18/457	1/0.03	25/11.3
LPS-1866-	629	750	835	N/A	1086	66/1676	2/51	18/457	1/0.03	27/12.2
LPS-1872-	655	786	875	N/A	1139	72/1829	2/51	18/457	1/0.03	29/13.2



Includes: two 24"H black support posts, two black support caps, and two 12"H divider panels. All mounting hardware included.

For optional brushed aluminum posts add suffix **AL** to end of code. i.e. LPS-2448-L-AL

LPS-2424-	528	606	652	N/A	848	24/610	2/51	24/610	1/0.03	18/8.2
LPS-2430-	564	646	708	N/A	919	30/762	2/51	24/610	1/0.03	22/10.0
LPS-2436-	593	690	755	N/A	982	36/914	2/51	24/610	1/0.03	26/11.8
LPS-2442-	626	727	808	N/A	1046	42/1067	2/51	24/610	1/0.03	30/13.6
LPS-2448-	660	773	859	N/A	1117	48/1219	2/51	24/610	1/0.03	32/14.5
LPS-2454-	694	818	912	N/A	1184	54/1372	2/51	24/610	1/0.03	34/15.4
LPS-2460-	725	862	960	N/A	1247	60/1524	2/51	24/610	1/0.03	38/17.2
LPS-2466-	762	900	1013	N/A	1316	66/1676	2/51	24/610	1/0.03	42/19.1
LPS-2472-	793	944	1064	N/A	1382	72/1829	2/51	24/610	1/0.03	44/20.0



Includes: two 36"H black support posts, two black support caps, three 12"H divider panels. All mounting hardware included.

For optional brushed aluminum posts add suffix **AL** to end of code. i.e. LPS-3648-L-AL

LPS-3624-	764	906	1012	N/A	1314	24/610	2/51	36/914	1/0.03	27/12.2
LPS-3630-	804	970	1093	N/A	1421	30/762	2/51	36/914	1/0.03	33/15.0
LPS-3636-	845	1034	1169	N/A	1519	36/914	2/51	36/914	1/0.03	39/17.7
LPS-3642-	888	1094	1254	N/A	1630	42/1067	2/51	36/914	1/0.03	45/20.4
LPS-3648-	931	1163	1328	N/A	1729	48/1219	2/51	36/914	1/0.03	48/21.8
LPS-3654-	972	1225	1409	N/A	1832	54/1372	2/51	36/914	1/0.03	51/23.1
LPS-3660-	1013	1289	1487	N/A	1932	60/1524	2/51	36/914	1/0.03	57/25.9
LPS-3666-	1057	1352	1568	N/A	2039	66/1676	2/51	36/914	1/0.03	63/28.6
LPS-3672-	1096	1417	1650	N/A	2140	72/1829	2/51	36/914	1/0.03	66/29.9

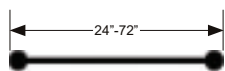

Drawing must be provided at time of order to ensure sufficient number of spacers are included.

Panel widths shown reflect size of worksurface.

Refer to page 103 for panel type insert options, finish codes.  
For additional specification instructions and laminate colours see pages 6-7.  
See Links Fabric cards for available selections.



CODE	PRICE					WIDTH (in/mm)	DEPTH (in/mm)	HEIGHT (in/mm)	VOLUME (ft3/m3)	WEIGHT (lbs/kg)
	(L)	(G,C,W)	(F)	(S)	(Z,X)					

Corner Panel Set



Includes: three 6"H black support posts, three black support caps, and two 6"H divider panels. All mounting hardware included.  
  
For optional brushed aluminum posts add suffix **AL** to end of code. i.e. CPS-4848-L6-AL

6" HIGH	CPS-3030-6	712	804	856	907	1114	30/762	30/762	6/152	1/0.03	18/8.2
	CPS-3636-6	748	863	917	978	1193	36/914	36/914	6/152	1/0.03	21/9.5
	CPS-4242-6	785	917	984	1050	1282	42/1067	42/1067	6/152	1/0.03	23/10.4
	CPS-4848-6	823	976	1050	1123	1368	48/1219	48/1219	6/152	1/0.03	27/12.2
	CPS-4842-6	804	946	1018	1088	1324	48/1219	42/1067	6/152	1/0.03	23/10.4
	CPS-4248-6	804	946	1018	1088	1324	42/1067	48/1219	6/152	1/0.03	23/10.4
	CPS-3630-6	726	834	887	942	1152	36/914	30/762	6/152	1/0.03	20/9.10
	CPS-3036-6	726	834	887	942	1152	30/762	36/914	6/152	1/0.03	20/9.10



Includes: three 12"H black support posts, three black support caps, and two 12"H divider panels. All mounting hardware included.  
  
For optional brushed aluminum posts add suffix **AL** to end of code. i.e. CPS-4848-L-AL

12" HIGH	CPS-3030-	712	804	856	907	1114	30/762	30/762	12/305	1/0.03	18/8.2
	CPS-3636-	748	863	917	978	1193	36/914	36/914	12/305	1/0.03	21/9.5
	CPS-4242-	785	917	984	1050	1282	42/1067	42/1067	12/305	1/0.03	23/10.4
	CPS-4848-	823	976	1050	1123	1368	48/1219	48/1219	12/305	1/0.03	27/12.2
	CPS-4842-	804	946	1018	1088	1324	48/1219	42/1067	12/305	1/0.03	23/10.4
	CPS-4248-	804	946	1018	1088	1324	42/1067	48/1219	12/305	1/0.03	23/10.4
	CPS-3630-	726	834	887	942	1152	36/914	30/762	12/305	1/0.03	20/9.10
	CPS-3036-	726	834	887	942	1152	30/762	36/914	12/305	1/0.03	20/9.10



Includes: three 18"H black support posts, three black support caps, and two 18"H divider panels. All mounting hardware included.  
  
For optional brushed aluminum posts add suffix **AL** to end of code. i.e. CPS-4848-18HL-AL

18" HIGH	CPS-3030-18H	862	1006	1075	N/A	1398	30/762	30/762	18/457	1/0.03	18/8.2
	CPS-3636-18H	912	1078	1158	N/A	1505	36/914	36/914	18/457	1/0.03	21/9.5
	CPS-4242-18H	964	1147	1244	N/A	1619	42/1067	42/1067	18/457	1/0.03	23/10.4
	CPS-4848-18H	1015	1223	1381	N/A	1793	48/1219	48/1219	18/457	1/0.03	27/12.2
	CPS-4842-18H	991	1182	1286	N/A	1672	48/1219	42/1067	18/457	1/0.03	23/10.4
	CPS-4248-18H	991	1182	1286	N/A	1672	42/1067	48/1219	18/457	1/0.03	23/10.4
	CPS-3630-18H	886	1042	1117	N/A	1453	36/914	30/762	18/457	1/0.03	20/9.10
	CPS-3036-18H	886	1042	1117	N/A	1453	30/762	36/914	18/457	1/0.03	20/9.10



Includes: three 24"H black support posts, three black support caps, and four 12"H divider panels. All mounting hardware included.  
  
For optional brushed aluminum posts add suffix **AL** to end of code. i.e. CPS-4848-24HL-AL

24" HIGH	CPS-3030-24H	1074	1206	1297	N/A	1687	30/762	30/762	24/610	1/0.03	36/16.3
	CPS-3636-24H	1105	1291	1397	N/A	1817	36/914	36/914	24/610	1/0.03	42/19.1
	CPS-4242-24H	1144	1378	1504	N/A	1955	42/1067	42/1067	24/610	1/0.03	46/20.9
	CPS-4848-24H	1206	1464	1676	N/A	2179	48/1219	48/1219	24/610	1/0.03	54/24.5
	CPS-4842-24H	1174	1418	1552	N/A	2017	48/1219	42/1067	24/610	1/0.03	46/20.9
	CPS-4248-24H	1174	1418	1552	N/A	2017	42/1067	48/1219	24/610	1/0.03	46/20.9
	CPS-3630-24H	1040	1250	1348	N/A	1752	36/914	30/762	24/610	1/0.03	40/18.1
	CPS-3036-24H	1040	1250	1348	N/A	1752	30/762	36/914	24/610	1/0.03	40/18.1



Includes: three 36"H black support posts, three black support caps, and six 12"H divider panels. All mounting hardware included.  
  
For optional brushed aluminum posts add suffix **AL** to end of code. i.e. CPS-4848-36HL-AL

36" HIGH	CPS-3030-36H	1438	1811	2014	N/A	2620	30/762	30/762	36/914	1/0.03	54/24.5
	CPS-3636-36H	1520	1938	2166	N/A	2816	36/914	36/914	36/914	1/0.03	63/28.6
	CPS-4242-36H	1603	2064	2333	N/A	3036	42/1067	42/1067	36/914	1/0.03	69/31.3
	CPS-4848-36H	1690	2196	2473	N/A	3234	48/1219	48/1219	36/914	1/0.03	81/36.7
	CPS-4842-36H	1648	2129	2410	N/A	3133	48/1219	42/1067	36/914	1/0.03	69/31.3
	CPS-4248-36H	1648	2129	2410	N/A	3133	42/1067	48/1219	36/914	1/0.03	69/31.3
	CPS-3630-36H	1481	1872	2090	N/A	2718	36/914	30/762	36/914	1/0.03	60/27.2
	CPS-3036-36H	1481	1872	2090	N/A	2718	30/762	36/914	36/914	1/0.03	60/27.2

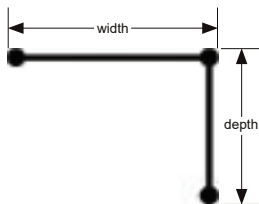

Drawing must be provided at time of order to ensure sufficient number of spacers are included.

Panel widths and depths shown reflect size of worksurface.

Refer to page 103 for panel type insert options, finish codes.  
For additional specification instructions and laminate colours see pages 6-7.  
See Links Fabric cards for available selections.



Angled Panel Set



CODE	(L)	(G,C,W)	PRICE			(F)	(S)	(Z,X)	WIDTH	DEPTH	HEIGHT	VOLUME	WEIGHT
			(in/mm)	(in/mm)	(in/mm)				(ft3/m3)	(lbs/kg)			

6"H	APS-4242-6	6	796	1002	1068	1133	1366	42/1067	42/1067	6/152	1/0.03	24/10.9
	APS-4848-6	6	907	1060	1133	1207	1451	48/1219	48/1219	6/152	1/0.03	28/12.7
	APS-6060-6	6	934	1086	1160	1234	1478	60/1524	60/1524	6/152	1/0.03	30/13.6

Includes: four 6"H black support posts, four black support caps, and three 6"H divider panel. All mounting hardware included.

For optional brushed aluminum posts add suffix **AL** to end of code. i.e. APS-4848-L6-AL



12"H	APS-4242-		796	1002	1068	1133	1366	42/1067	42/1067	12/305	1/0.03	24/10.9
	APS-4848-		907	1060	1133	1207	1451	48/1219	48/1219	12/305	1/0.03	28/12.7
	APS-6060-		934	1086	1160	1234	1478	60/1524	60/1524	12/305	1/0.03	30/13.6

Includes: four 12"H black support posts, four black support caps, and three 12"H divider panel. All mounting hardware included.

For optional brushed aluminum posts add suffix **AL** to end of code. i.e. APS-4848-L-AL



18"H	APS-4242-18H		1056	1237	1334	N/A	1710	42/1067	42/1067	18/457	1/0.03	24/10.9
	APS-4848-18H		1105	1313	1471	N/A	1884	48/1219	48/1219	18/457	1/0.03	28/12.7
	APS-6060-18H		1132	1339	1499	N/A	1910	60/1524	60/1524	18/457	1/0.03	30/13.6

Includes: four 18"H black support posts, four black support caps, and three 18"H divider panel. All mounting hardware included.

For optional brushed aluminum posts add suffix **AL** to end of code. i.e. APS-4848-18HL-AL

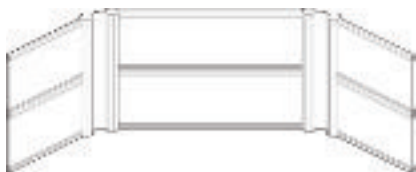

24"H	APS-4242-24H		1238	1472	1600	N/A	2052	42/1067	42/1067	24/610	1/0.03	48/21.8
	APS-4848-24H		1302	1560	1772	N/A	2274	48/1219	48/1219	24/610	1/0.03	56/25.4
	APS-6060-24H		1330	1586	1799	N/A	2302	60/1524	60/1524	24/610	1/0.03	60/27.2

Includes: four 24"H black support posts, four black support caps, and six 12"H divider panels. All mounting hardware included.

For optional brushed aluminum posts add suffix **AL** to end of code. i.e. APS-4848-24HL-AL



36"H	APS-4242-36H		1736	2198	2466	N/A	3170	42/1067	42/1067	24/610	1/0.03	74/33.6
	APS-4848-36H		1823	2329	2621	N/A	3367	48/1219	48/1219	24/610	1/0.03	86/39.0
	APS-6060-36H		1849	2356	2647	N/A	3394	60/1524	60/1524	24/610	1/0.03	90/40.8

Includes: four 36"H black support posts, four black support caps, and none 12"H divider panels. All mounting hardware included.

For optional brushed aluminum posts add suffix **AL** to end of code. i.e. APS-4848-36HL-AL

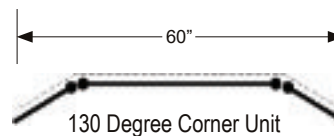
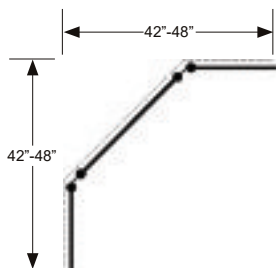

Panel widths and depths shown reflect code size of ACU worksurface. Additional support posts may be required for some applications.

**\*Drawing must be provided at time of order to ensure sufficient number of spacers are included\***

Refer to page 103 for panel type insert options, finish codes.  
For additional specification instructions and laminate colours see pages 6-7.  
See Links Fabric cards for available selections.



PRICE WIDTH DEPTH HEIGHT VOLUME WEIGHT

CODE (L) (G,C,W) (F) (S) (Z,X) (in/mm) (in/mm) (in/mm) (ft3/m3) (lbs/kg)

**Linear Transaction Set**



Includes: two 6"H black support posts, one transaction top, and one 6"H divider panel. All mounting hardware included.

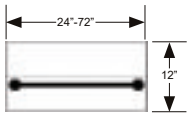

For optional brushed aluminum posts add suffix **AL** to end of code. i.e. LTS-1248-L6-AL

6" HIGH	CODE	(L)	(G,C,W)	(F)	(S)	(Z,X)	WIDTH (in/mm)	DEPTH (in/mm)	HEIGHT (in/mm)	VOLUME (ft3/m3)	WEIGHT (lbs/kg)
LTS-1224-6	401	442	460	485	595	24/610	12/305	6/152	1.0/0.03	18/8.2	
LTS-1230-6	422	468	494	518	642	30/762	12/305	6/152	1.0/0.03	21/9.5	
LTS-1236-6	442	497	527	554	684	36/914	12/305	6/152	1.0/0.03	25/11.3	
LTS-1242-6	460	527	563	592	728	42/1067	12/305	6/152	1.2/0.03	29/13.2	
LTS-1248-6	479	553	592	626	769	48/1219	12/305	6/152	1.3/0.04	31/14.1	
LTS-1254-6	497	581	624	664	815	54/1372	12/305	6/152	1.5/0.04	34/15.4	
LTS-1260-6	515	612	658	696	856	60/1524	12/305	6/152	1.6/0.05	38/17.2	
LTS-1266-6	536	641	692	733	898	66/1676	12/305	6/152	1.8/0.05	41/18.6	
LTS-1272-6	553	670	724	766	941	72/1829	12/305	6/152	2.0/0.06	44/20.0	



Includes: two 12"H black support posts, one transaction top, and one 12"H divider panel. All mounting hardware included.

For optional brushed aluminum posts add suffix **AL** to end of code. i.e. LTS-1248-L-AL

12" HIGH	CODE	(L)	(G,C,W)	(F)	(S)	(Z,X)	WIDTH (in/mm)	DEPTH (in/mm)	HEIGHT (in/mm)	VOLUME (ft3/m3)	WEIGHT (lbs/kg)
LTS-1224-	401	442	460	485	595	24/610	12/305	12/305	1.0/0.03	18/8.2	
LTS-1230-	422	468	494	518	642	30/762	12/305	12/305	1.0/0.03	21/9.5	
LTS-1236-	442	497	527	554	684	36/914	12/305	12/305	1.0/0.03	25/11.3	
LTS-1242-	460	527	563	592	728	42/1067	12/305	12/305	1.2/0.03	29/13.2	
LTS-1248-	479	553	592	626	769	48/1219	12/305	12/305	1.3/0.04	31/14.1	
LTS-1254-	497	581	624	664	815	54/1372	12/305	12/305	1.5/0.04	34/15.4	
LTS-1260-	515	612	658	696	856	60/1524	12/305	12/305	1.6/0.05	38/17.2	
LTS-1266-	536	641	692	733	898	66/1676	12/305	12/305	1.8/0.05	41/18.6	
LTS-1272-	553	670	724	766	941	72/1829	12/305	12/305	2.0/0.06	44/20.0	



Radius End Left Add **RL** to code. i.e. LTS-1248-L-RL



Radius End Right Add **RR** to code. i.e. LTS-1248-L-RR

**Drawing must be provided at time of order to ensure sufficient number of spacers are included.**

**Corner Transaction Set**



Includes: three 6"H black support posts, one corner transaction top, and two 6"H divider panels. All mounting hardware included.

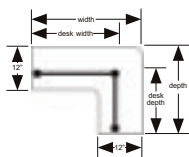

For optional brushed aluminum posts add suffix **AL** to end of code. i.e. CTS-4848-L6-AL

6" HIGH	CODE	(L)	(G,C,W)	(F)	(S)	(Z,X)	WIDTH (in/mm)	DEPTH (in/mm)	HEIGHT (in/mm)	VOLUME (ft3/m3)	WEIGHT (lbs/kg)
CTS-3030-6	800	899	949	1002	1232	36/914	36/914	6/152	1.5/0.04	36/16.3	
CTS-3636-6	842	906	1013	1043	1316	42/1067	42/1067	6/152	1.5/0.04	41/18.6	
CTS-4242-6	881	1013	1084	1091	1406	48/1219	48/1219	6/152	1.7/0.05	46/20.9	
CTS-4848-6	917	1069	1146	1146	1490	54/1372	54/1372	6/152	1.7/0.05	54/24.5	
CTS-4842-6	899	1040	1115	1182	1446	54/1372	48/1219	6/152	1.7/0.05	46/20.9	
CTS-4248-6	899	1040	1115	1182	1446	48/1219	54/1372	6/152	1.7/0.05	46/20.9	
CTS-3630-6	823	917	928	976	1193	42/1067	36/914	6/152	1.5/0.04	39/17.7	
CTS-3036-6	823	917	928	976	1193	36/914	42/1067	6/152	1.5/0.04	39/17.7	
CTS-3018-6	767	834	863	914	1121	36/914	24/610	6/152	1.0/0.03	31/14.1	
CTS-1830-6	767	834	863	914	1121	24/610	36/914	6/152	1.0/0.03	31/14.1	
CTS-2418-6	748	812	842	889	1093	30/762	24/610	6/152	1.0/0.03	31/14.1	
CTS-1824-6	748	812	842	889	1093	24/610	30/762	6/152	1.0/0.03	31/14.1	



Includes: three 12"H black support posts, one corner transaction top, and two 12"H divider panels. All mounting hardware included.

For optional brushed aluminum posts add suffix **AL** to end of code. i.e. CTS-4848-L-AL

12" HIGH	CODE	(L)	(G,C,W)	(F)	(S)	(Z,X)	WIDTH (in/mm)	DEPTH (in/mm)	HEIGHT (in/mm)	VOLUME (ft3/m3)	WEIGHT (lbs/kg)
CTS-3030-	800	899	949	1002	1232	36/914	36/914	12/305	1.5/0.04	36/16.3	
CTS-3636-	842	906	1013	1043	1316	42/1067	42/1067	12/305	1.5/0.04	41/18.6	
CTS-4242-	881	1013	1084	1091	1406	48/1219	48/1219	12/305	1.7/0.05	46/20.9	
CTS-4848-	917	1069	1146	1146	1490	54/1372	54/1372	12/305	1.7/0.05	54/24.5	
CTS-4842-	899	1040	1115	1182	1446	54/1372	48/1219	12/305	1.7/0.05	46/20.9	
CTS-4248-	899	1040	1115	1182	1446	48/1219	54/1372	12/305	1.7/0.05	46/20.9	
CTS-3630-	823	917	928	976	1193	42/1067	36/914	12/305	1.5/0.04	39/17.7	
CTS-3036-	823	917	928	976	1193	36/914	42/1067	12/305	1.5/0.04	39/17.7	
CTS-3018-	767	834	863	914	1121	36/914	24/610	12/305	1.0/0.03	31/14.1	
CTS-1830-	767	834	863	914	1121	24/610	36/914	12/305	1.0/0.03	31/14.1	
CTS-2418-	748	812	842	889	1093	30/762	24/610	12/305	1.0/0.03	31/14.1	
CTS-1824-	748	812	842	889	1093	24/610	30/762	12/305	1.0/0.03	31/14.1	

**Drawing must be provided at time of order to ensure sufficient number of spacers are included.**

Refer to page 103 for panel type insert options, finish codes.  
For additional specification instructions and laminate colours see pages 6-7.  
See Links Fabric cards for available selections.

CODE	PRICE					WIDTH (in/mm)	DEPTH (in/mm)	HEIGHT (in/mm)	VOLUME (ft <sup>3</sup> /m <sup>3</sup> )	WEIGHT (lbs/kg)
	(L)	(G,C,W)	(F)	(S)	(Z,X)					

**Angled Corner Transaction Set**



Includes: Four 6"H or 12"H black posts, one corner transaction top and three 6"H or 12"H privacy divider panels. All mounting hardware is included.

For optional brushed aluminum posts add suffix **AL** to end of code. i.e. ATS-4848-L-AL

6"H	ATS-4242-6	1132	1266	1355	1478	1762	48/1219	48/1219	6/152	1.7/0.05	46/20.9
	ATS-4848-6	1170	1322	1432	1570	1860	54/1372	54/1372	6/152	1.7/0.05	54/24.5
	ATS-6060-6	1362	1560	1715	1870	2232	66/1676	18/457	6/152	3.4/0.09	84/38.1
12"H	ATS-4242-	1132	1266	1355	1478	1762	48/1219	48/1219	12/305	1.7/0.05	46/20.9
	ATS-4848-	1170	1322	1432	1570	1860	54/1372	54/1372	12/305	1.7/0.05	54/24.5
	ATS-6060-	1362	1560	1715	1870	2232	66/1676	18/457	12/305	3.4/0.09	84/38.1

**Additional support posts may be required for some applications. Contact Customer Service for details.**

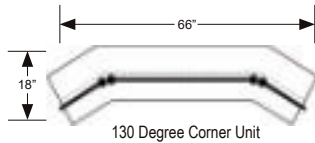
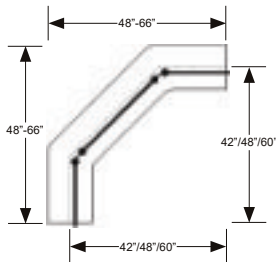

130 Degree Corner Unit

**Quad Transaction Set**



Divide multi-station clusters with an attractive transaction set. Comes complete with four 12"H divider panels, one quad and four linear transaction tops, eight 12"H black support posts, four center inserts and all hardware.

For optional brushed aluminum posts add suffix **AL** to end of code. i.e. QTS-4848-F-AL

12"H	QTS-3636-	1817	2083	2236	2356	2906	72/1829	72/1829	12/305	4.0/0.11	72/32.7
	QTS-4242-	1891	2160	2311	2438	3006	84/2134	84/2134	12/305	4.0/0.11	82/37.2
	QTS-4848-	1972	2273	2462	2606	3202	96/2438	96/2438	12/305	4.0/0.11	92/41.7

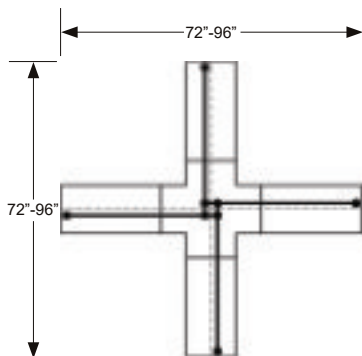

Refer to page 103 for panel type insert options, finish codes.  
For additional specification instructions and laminate colours see pages 6-7.  
See Links Fabric cards for available selections.



Round Transaction Set



Divide single island worksurfaces with an attractive transaction set. Comes complete with divider panel, rounded end transaction top, two black support posts and all hardware.

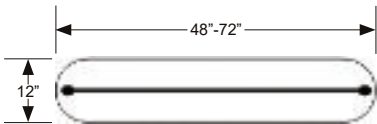

CODE	PRICE					WIDTH (in/mm)	DEPTH (in/mm)	HEIGHT (in/mm)	VOLUME (ft3/m3)	WEIGHT (lbs/kg)
	(L)	(G,C,W)	(F)	(S)	(Z,X)					

6"H	RTS-1248-	6	553	629	670	706	869	48/1219	12/305	6/152	1.3/0.04	31/14.1
	RTS-1260-	6	592	688	736	773	955	60/1524	12/305	6/152	1.6/0.05	38/17.2
	RTS-1266-	6	612	745	768	808	998	66/1676	12/305	6/152	1.8/0.05	44/20.0
	RTS-1272-	6	649	821	824	874	1074	72/1829	12/305	6/152	2.0/0.06	51/23.1

12"H	RTS-1248-		553	629	670	706	869	48/1219	12/305	12/305	1.3/0.04	31/14.1
	RTS-1260-		592	688	736	773	955	60/1524	12/305	12/305	1.6/0.05	38/17.2
	RTS-1266-		612	745	768	808	998	66/1676	12/305	12/305	1.8/0.05	44/20.0
	RTS-1272-		649	821	824	874	1074	72/1829	12/305	12/305	2.0/0.06	51/23.1

For optional brushed aluminum posts add suffix **AL** to end of code. i.e. RTS-1248-L-AL

**Drawing must be provided at time of order to ensure sufficient number of spacers are included.**

Elliptical Transaction Set



Divide single island worksurfaces with an attractive transaction set. Comes complete with divider panel, elliptical transaction top, two black support posts and all hardware.

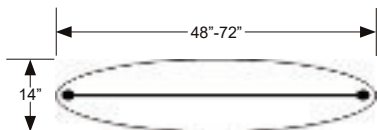

6"H	ETS-1448-	6	553	629	670	706	869	48/1219	14/356	6/152	1.3/0.04	31/14.1
	ETS-1460-	6	592	688	736	773	955	60/1524	14/356	6/152	1.6/0.05	38/17.2
	ETS-1466-	6	612	745	768	808	998	66/1676	14/356	6/152	1.8/0.05	44/20.0
	ETS-1472-	6	649	821	824	874	1074	72/1829	14/356	6/152	2.0/0.06	51/23.1

12"H	ETS-1448-		553	629	670	706	869	48/1219	14/356	12/305	1.3/0.04	31/14.1
	ETS-1460-		592	688	736	773	955	60/1524	14/356	12/305	1.6/0.05	38/17.2
	ETS-1466-		612	745	768	808	998	66/1676	14/356	12/305	1.8/0.05	44/20.0
	ETS-1472-		649	821	824	874	1074	72/1829	14/356	12/305	2.0/0.06	51/23.1

For optional brushed aluminum posts add suffix **AL** to end of code. i.e. ETS-1448-L-AL

**Drawing must be provided at time of order to ensure sufficient number of spacers are included.**

Refer to page 103 for panel type insert options, finish codes.  
For additional specification instructions and laminate colours see pages 6-7.  
See Links Fabric cards for available selections.





Half Round Table



Half Round, multi-function table tops. Links two 24" work surfaces into one 48" peninsula or two 30" work surfaces into one 60" peninsula. All hardware included.

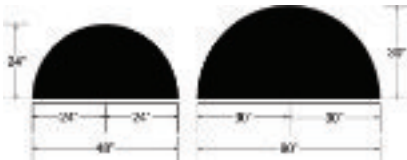

CODE	PRICE	WIDTH (in/mm)	DEPTH (in/mm)	HEIGHT (in/mm)	VOLUME (ft <sup>3</sup> /m <sup>3</sup> )	WEIGHT (lbs/kg)
DTI-2448-H	572	48/1219	24/610	29/737	2/0.06	38/17
DTI-3060-H	614	60/1524	30/762	29/737	3/0.08	50/23
C2	148	Opt. black double post leg - add C2 to end of code				
C3	0	Opt. silver single post leg - add C3 to end of code				
C4	148	Opt. silver double post leg - add C4 to end of code				

End Table

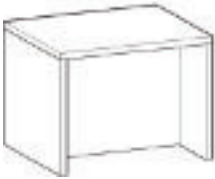

TBL-2024-ET	534	24/610	20/508	18/457	6/0.17	36/16
-------------	-----	--------	--------	--------	--------	-------

Coffee Table

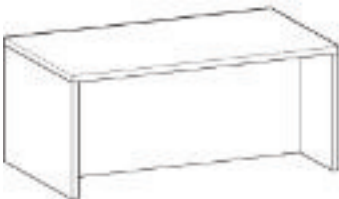

TBL-2442-CF	534	42/1067	24/610	18/457	7/0.20	44/20
-------------	-----	---------	--------	--------	--------	-------

Lecturn

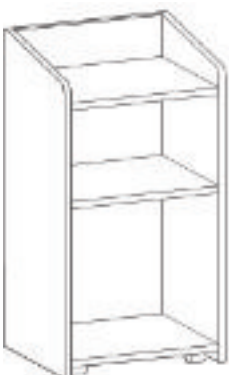







Mobile presentation lecturn with fixed shelves.

CAB-2024-48-LTNS	1171	24/610	20/508	48/1219	16/0.45	100/45
------------------	------	--------	--------	---------	---------	--------

For additional specification instructions see pages 6-7.

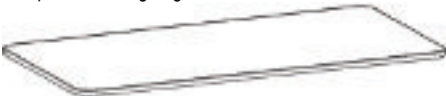

tables

MODEL NO.	WIDTH (in/mm)	DEPTH (in/mm)	HEIGHT (in/mm)	PRICE - BASE STYLE			
				TB	VB	XB	
<b>Racetrack Shape Top</b> 1" top, 1" matching edge.							
 1"	TBL-6-TR-	72/1829	36/914	29/737	1252	1252	1136
	TBL-8-TR-	96/2438	42/1067	29/737	1445	1445	1329
	TBL-10-TR-	120/3048	48/1219	29/737	2202	2202	2086
	TBL-12-TR-	144/3658	48/1219	29/737	2358	2358	2242
	TBL-14-TR-	168/4267	48/1219	29/737	2890	2890	2658
	TBL-16-TR-	192/4877	48/1219	29/737	3044	3044	2932
1" top with 1.5" black bullnose polymer edge.							
 1" w/ 1.5" BN	TBL-6-TR-BN-	72/1829	36/914	29/737	1298	1298	1182
	TBL-8-TR-BN-	96/2438	42/1067	29/737	1541	1541	1425
	TBL-10-TR-BN-	120/3048	48/1219	29/737	2379	2379	2263
	TBL-12-TR-BN-	144/3658	48/1219	29/737	2937	2937	2821
	TBL-14-TR-BN-	168/4267	48/1219	29/737	3254	3254	3022
	TBL-16-TR-BN-	192/4877	48/1219	29/737	3475	3475	3363
<b>Boat Shape Top</b> 1" top, 1" matching edge.							
 1"	TBL-6-BS-	72/1829	36/914	29/737	1252	1252	1136
	TBL-8-BS-	96/2438	42/1067	29/737	1445	1445	1329
	TBL-10-BS-	120/3048	48/1219	29/737	2202	2202	2086
	TBL-12-BS-	144/3658	48/1219	29/737	2358	2358	2242
	TBL-14-BS-	168/4267	48/1219	29/737	2890	2890	2658
	TBL-16-BS-	192/4877	48/1219	29/737	3044	3044	2932
<b>Rectangular Shape Top</b> 1" top, 1" matching edge.							
 1"	TBL-6-RC-	72/1829	36/914	29/737	1252	1252	1136
	TBL-8-RC-	96/2438	42/1067	29/737	1445	1445	1329
	TBL-10-RC-	120/3048	48/1219	29/737	2202	2202	2086
	TBL-12-RC-	144/3658	48/1219	29/737	2358	2358	2242
	TBL-14-RC-	168/4267	48/1219	29/737	2890	2890	2658
	TBL-16-RC-	192/4877	48/1219	29/737	3044	3044	2932
<b>Square Shape Top</b> 1" top, 1" matching edge.							
 1"	TBL-3030-SQ-	30/762	30/762	29/737	N/A	N/A	657
	TBL-3636-SQ-	36/914	36/914	29/737	N/A	N/A	677
	TBL-4242-SQ-	42/1067	42/1067	29/737	N/A	N/A	750
	TBL-4848-SQ-	48/1219	48/1219	29/737	N/A	N/A	821
	TBL-5454-SQ-	54/1372	54/1372	29/737	N/A	N/A	1199
<b>Round Shape Top</b> 1" top, 1" matching edge.							
 1"	TBL-3030-RD-	30/762	30/762	29/737	N/A	N/A	657
	TBL-3636-RD-	36/914	36/914	29/737	N/A	N/A	677
	TBL-4242-RD-	42/1067	42/1067	29/737	N/A	N/A	720
	TBL-4848-RD-	48/1219	48/1219	29/737	N/A	N/A	821
	TBL-5454-RD-	54/1372	54/1372	29/737	N/A	N/A	1199
1" top with 1.5" black bullnose polymer edge.							
 1" w/ 1.5" BN	TBL-3030-RD-BN-	30/762	30/762	29/737	N/A	N/A	711
	TBL-3636-RD-BN-	36/914	36/914	29/737	N/A	N/A	739
	TBL-4242-RD-BN-	42/1067	42/1067	29/737	N/A	N/A	776
	TBL-4848-RD-BN-	48/1219	48/1219	29/737	N/A	N/A	876
	TBL-5454-RD-BN-	54/1372	54/1372	29/737	N/A	N/A	1267

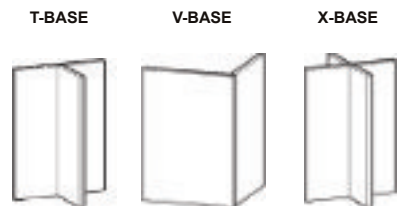

For additional specification instructions see pages 6-7.



PRICE - BASE STYLE

D1 (BLK)	D3 (SIL)	C1 (BLK)	C3 (SIL)	SB	SH	RB	RH
1878	1878	1234	1234	N/A	N/A	2022	2420
2071	2071	1723	1723	2227	2627	2905	3502
2836	2836	1870	1870	3070	3670	3052	3649
2992	2992	2322	2322	3226	3826	3898	4694
3524	3524	2854	2854	3758	4358	4430	5226
3678	3678	3008	3008	4608	5408	4584	5380

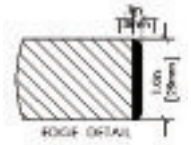

1924	1924	1280	1280	N/A	N/A	2068	2466
2167	2167	1819	1819	2323	2723	3001	3598
3013	3013	2047	2047	3247	3847	3229	3826
3571	3571	2901	2901	3805	4405	4477	5273
3888	3888	3218	3218	4122	4722	4794	5590
4109	4109	3439	3439	5039	5839	5015	5811

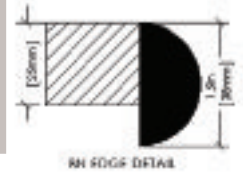

1878	1878	1234	1234	N/A	N/A	2022	2420
2071	2071	1723	1723	2227	2627	2905	3502
2836	2836	1870	1870	3070	3670	3052	3649
2992	2992	2322	2322	3226	3826	3898	4694
3524	3524	2854	2854	3758	4358	4430	5226
3678	3678	3008	3008	4608	5408	4584	5380

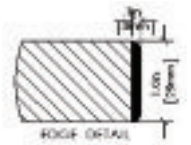

1878	1878	1234	1234	N/A	N/A	2022	2420
2071	2071	1723	1723	2227	2627	2905	3502
2836	2836	1870	1870	3070	3670	3052	3649
2992	2992	2322	2322	3226	3826	3898	4694
3524	3524	2854	2854	3758	4358	4430	5226
3678	3678	3008	3008	4608	5408	4584	5830

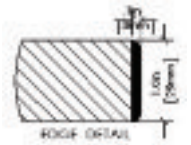

1028	1028	1002	1002	1106	1306	N/A	N/A
1048	1048	1022	1022	1126	1326	N/A	N/A
1091	1091	1065	1065	1169	1369	N/A	N/A
N/A	N/A	1136	1136	1240	1440	N/A	N/A
N/A	N/A	1250	1250	1384	1586	N/A	N/A

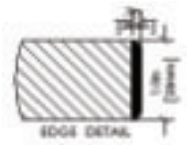

1028	1028	1002	1002	N/A	N/A	N/A	N/A
1048	1048	1022	1022	1126	1326	N/A	N/A
1091	1091	1065	1065	1169	1369	N/A	N/A
1162	1162	1136	1136	1240	1440	N/A	N/A
N/A	N/A	1250	1250	1384	1586	N/A	N/A

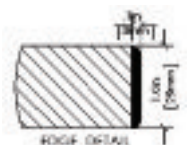

1082	1082	1056	1056	N/A	N/A	N/A	N/A
1110	1110	1084	1084	1188	1388	N/A	N/A
1147	1147	1121	1121	1225	1425	N/A	N/A
1217	1217	1191	1191	1295	1495	N/A	N/A
N/A	N/A	1318	1318	1452	1654	N/A	N/A

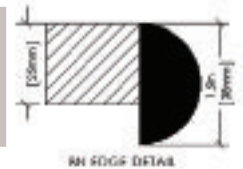

DRUM BASE BLACK

DRUM BASE SILVER

COLUMN BASE BLACK

COLUMN BASE SILVER

SQUARE BASE

SQUARE BASE HINGED

RECTANGULAR BASE

RECTANGULAR BASE HINGED

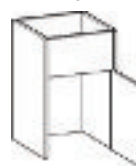
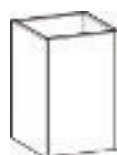



**Racetrack Shape Top**

1" thick top with matching edge.



CODE	PRICE	WIDTH (in/mm)	DEPTH (in/mm)	HEIGHT (in/mm)	VOLUME (ft <sup>3</sup> /m <sup>3</sup> )	WEIGHT (lbs/kg)
TBL-0006-TPTR	642	72/1829	36/914	1/25	2/0.06	80/36
TBL-0008-TPTR	835	96/2438	42/1067	1/25	3/0.08	95/43
TBL-0010-TPTR	982	120/3048	48/1219	1/25	4/0.11	115/52
TBL-0012-TPTR	1138	144/3658	48/1219	1/25	4/0.11	160/73
TBL-0014-TPTR	1670	168/4267	48/1219	1/25	5/0.14	190/86
TBL-0016-TPTR	1824	192/4877	48/1219	1/25	6/0.17	220/100



120"W to 192"W tops ship in two pieces

1" thick top with 1.5" black bullnose polymer edge.



TBL-0006-TPTR-BN	688	72/1829	36/914	1/25	2/0.06	80/36
TBL-0008-TPTR-BN	931	96/2438	42/1067	1/25	3/0.08	95/43
TBL-0010-TPTR-BN	1159	120/3048	48/1219	1/25	4/0.11	115/52
TBL-0012-TPTR-BN	1717	144/3658	48/1219	1/25	4/0.11	160/73
TBL-0014-TPTR-BN	2034	168/4267	48/1219	1/25	5/0.14	190/86
TBL-0016-TPTR-BN	2255	192/4877	48/1219	1/25	6/0.17	220/100

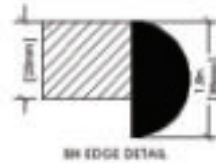

120"W to 192"W tops ship in two pieces

**Round Top**

1" thick top with matching edge.



TBL-3030-TPRD	410	30/762	30/762	1/25	1/0.03	25/11
TBL-3636-TPRD	430	36/914	36/914	1/25	2/0.06	30/14
TBL-4242-TPRD	473	42/1067	42/1067	1/25	2/0.06	45/20
TBL-4848-TPRD	544	48/1219	48/1219	1/25	3/0.08	55/25
TBL-5454-TPRD	658	54/1372	54/1372	1/25	4/0.11	70/32



1" thick top with 1.5" black bullnose polymer edge.



TBL-3030-TPRD-BN	464	30/762	30/762	1/25	1/0.03	30/14
TBL-3636-TPRD-BN	492	36/914	36/914	1/25	2/0.06	40/18
TBL-4242-TPRD-BN	529	42/1067	42/1067	1/25	2/0.06	55/25
TBL-4848-TPRD-BN	599	48/1219	48/1219	1/25	3/0.08	70/32
TBL-5454-TPRD-BN	726	54/1372	54/1372	1/25	4/0.11	85/39



For additional specification instructions see pages 6-7.  
See pages 118-121 for base options.

**Boat Shape Top**

1" thick top with matching edge.



CODE	PRICE	WIDTH (in/mm)	DEPTH (in/mm)	HEIGHT (in/mm)	VOLUME (ft3/m3)	WEIGHT (lbs/kg)
------	-------	------------------	------------------	-------------------	--------------------	--------------------

TBL-0006-TPBS	642	72/1829	36/914	1/25	2/0.06	80/36
TBL-0008-TPBS	835	96/2438	42/1067	1/25	3/0.08	95/43
TBL-0010-TPBS	982	120/3048	48/1219	1/25	4/0.11	115/52
TBL-0012-TPBS	1138	144/3658	48/1219	1/25	4/0.11	160/73
TBL-0014-TPBS	1670	168/4267	48/1219	1/25	5/0.14	190/86
TBL-0016-TPBS	1824	192/4877	48/1219	1/25	6/0.17	220/100



120"W to 192"W tops ship in two pieces

**Rectangular Top**

1" thick top with matching edge.



\*\*If you do not want radius corners add **-QD** to code\*\*  
example TBL-0006-TPRC-QD

TBL-0006-TPRC	642	72/1829	36/914	1/25	2/0.06	80/36
TBL-0008-TPRC	835	96/2438	42/1067	1/25	3/0.08	95/43
TBL-0010-TPRC	982	120/3048	48/1219	1/25	4/0.11	115/52
TBL-0012-TPRC	1138	144/3658	48/1219	1/25	4/0.11	160/73
TBL-0014-TPRC	1670	168/4267	48/1219	1/25	5/0.14	190/86
TBL-0016-TPRC	1824	192/4877	48/1219	1/25	6/0.17	220/100



120"W to 192"W tops ship in two pieces

**Square Top**

1" thick top with matching edge.



\*\*If you do not want radius corners add **-QD** to code\*\*  
example TBL-4242-TPSQ-QD

TBL-3030-TPSQ	410	30/762	30/762	1/25	1/0.03	25/11
TBL-3636-TPSQ	430	36/914	36/914	1/25	2/0.06	30/14
TBL-4242-TPSQ	473	42/1067	42/1067	1/25	2/0.06	45/20
TBL-4848-TPSQ	544	48/1219	48/1219	1/25	3/0.08	55/25
TBL-5454-TPSQ	658	54/1372	54/1372	1/25	4/0.11	70/32



**Table Connectors**

Table locking hardware for surface connection.  
Includes male & female ends.

ACC-TLH	41
---------	----



For additional specification instructions see pages 6-7.  
See pages 118-121 for base options.

table bases

Square Base



20" for 36"D-42"D top depth.

24" for 48"D top depth.

Shipped K.D.

CODE	PRICE	WIDTH (in/mm)	DEPTH (in/mm)	HEIGHT (in/mm)	VOLUME (ft3/m3)	WEIGHT (lbs/kg)
------	-------	------------------	------------------	-------------------	--------------------	--------------------

29H	TBL-20-SB-29	696	20/508	20/508	28/711	2/0.06	60/27
	TBL-24-SB-29	696	24/610	24/610	28/711	2/0.06	62/28
	TBL-30-SB-29	726	30/762	30/762	28/711	2/0.06	66/30

Square Base - Hinged



Square base with right hinged access door (non-locking).

20" for 30"D to 42"D top

24" for 48"D top

30" for 54"D top

Shipped K.D.

29H	TBL-20-SB-29-HING	896	20/508	20/508	28/711	2/0.06	60/27
	TBL-24-SB-29-HING	896	24/610	24/610	28/711	2/0.06	62/28
	TBL-30-SB-29-HING	928	30/762	30/762	28/711	2/0.06	66/30

Rectangular Base



20" for 36"D to 48"D top.

Shipped K.D.

TBL-20-RB-29	690	20/508	10/254	28/711	2/0.06	50/23
--------------	-----	--------	--------	--------	--------	-------

Rectangular Base - Hinged



Rectangular base with right hinged access door (non-locking).

20" for 36"D to 48"D top.

Shipped K.D.

TBL-20-RB-29-HING	889	20/508	10/254	28/711	2/0.06	50/23
-------------------	-----	--------	--------	--------	--------	-------

See to pages 116-117 for available 1" table tops.  
For additional specification instructions see pages 6-7.

## table bases

### X-Base



20" for 30"D-36"D top depth.  
24" for 42"D top depth.  
30" for 48"D top depth.  
36" for 54"D top depth.

Shipped K.D.

	CODE	PRICE	WIDTH (in/mm)	DEPTH (in/mm)	HEIGHT (in/mm)	VOLUME (ft3/m3)	WEIGHT (lbs/kg)
29H	TBL-20-XB-29	247	20/508	20/508	28/711	2/0.06	35/16
	TBL-24-XB-29	247	24/610	24/610	28/711	2/0.06	40/18
	TBL-30-XB-29	277	30/762	30/762	28/711	2/0.06	45/20
	TBL-36-XB-29	541	36/914	36/914	28/711	2/0.06	70/32
42H	TBL-20-XB-42	310	20/508	20/508	41/1041	3/0.08	45/20
	TBL-24-XB-42	310	24/610	24/610	41/1041	3/0.08	50/23
	TBL-30-XB-42	341	30/762	30/762	41/1041	3/0.08	55/25
	TBL-36-XB-42	649	36/914	36/914	41/1041	3/0.08	80/36

### T-Base



20" for 36"D to 42"D top depth

24" for 48"D top

Shipped K.D.

29H	TBL-20-TB-29	305	20/508	13/330	28/711	2.0/0.06	55/25
	TBL-24-TB-29	305	24/610	13/330	28/711	2.0/0.06	60/27
42H	TBL-20-TB-42	367	20/508	13/330	41/1041	2.5/0.07	70/32
	TBL-24-TB-42	367	24/610	13/330	41/1041	2.5/0.07	72/33

### V-Base

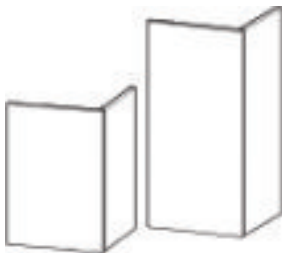

20" for 36"D-48"D top depth.

Shipped K.D.

TBL-20-VB-29	305	20/508	14/356	28/711	2.0/0.06	60/27
TBL-20-VB-42	367	20/508	14/356	41/1041	2.5/0.07	70/32

### Drum Base



Available in Black (BK)  
and Silver (SL).

WT = With Weight

ACC-18-DB	618	18/457	18/457	28/711	6/0.17	80/36
ACC-18-DB-WT	696	18/457	18/457	28/711	6/0.17	130/59

### Column Base



Available in Black (C1)  
and Silver (C3).

ACC-C1	148	3/76	3/76	28/711	1/0.03	3/1
ACC-C3	148	3/76	3/76	28/711	1/0.03	3/1

See to pages 116-117 for available 1" table tops.  
For additional specification instructions see pages 6-7.







**Metal T-Base**



For 30"-48" top depth

Available in Black (-BK) and Silver (-SL).

CODE	PRICE	WIDTH (in/mm)	DEPTH (in/mm)	HEIGHT (in/mm)	VOLUME (ft3/m3)	WEIGHT (lbs/kg)
------	-------	------------------	------------------	-------------------	--------------------	--------------------

TBL-26-MTB	379	26/660	11/279	28/711	6.5/0.18	11.5/5
------------	-----	--------	--------	--------	----------	--------

**Metal X-Base**



26" is for 30-36" top depth.  
34" is for 42-48" top depth.

Available in Black (-BK) and Silver (-SL).

TBL-26-MXB	454	26/660	26/660	28/711	13/0.37	13.5/6
TBL-34-MXB	468	34/864	34/864	28/711	22/0.62	14.5/7

**Trumpet Base**



24" is for 30-36" top depth.  
30" is for 42-48" top depth.

WT = With Weight

Available in Black (-BK) and Silver (-SL).

TBL-24-MTRB	796	24/610	24/610	28/711	11.2/0.32	20/9
TBL-24-MTRB-WT	952	24/610	24/610	28/711	11.2/0.32	20/9
TBL-30-MTRB	1109	30/762	30/762	28/711	17.2/0.49	26/12
TBL-30-MTRB-WT	1333	30/762	30/762	28/711	17.2/0.49	26/12

**Flat Base**



24" is for 30-36" top depth.  
36" is for 42-48" top depth.

Available in Black (-BK) and Silver (-SL).

TBL-24-MFB	1330	24/610	24/610	28/711	11.2/0.32	34/15
TBL-36-MFB	2327	36/914	36/914	28/711	24.5/0.69	78.5/36

**Mobile Column Base**



Post leg with locking caster.

**C1** = Black  
**C3** = Silver

ACC-C1-MB	211	3/76	3/76	28/711	0.2/0.01	4.5/2
ACC-C3-MB	211	3/76	3/76	28/711	0.2/0.01	4.5/2

See to pages 116-117 for available 1" table tops.  
For additional specification instructions see pages 6-7.



Desk Components



12"D Connection Gable

CODE	PRICE	WIDTH (in/mm)	DEPTH (in/mm)	HEIGHT (in/mm)	VOLUME (ft3/m3)	WEIGHT (lbs/kg)
------	-------	------------------	------------------	-------------------	--------------------	--------------------

ACC-CG12	112	12/305	1/25	28/711	0.5/0.01	8/4
----------	-----	--------	------	--------	----------	-----

\*All support gables are drilled non-handed for left and right connection\*



12"D Finished Gable

ACC-LI12	112	12/305	1/25	28/711	0.5/0.01	8/4
----------	-----	--------	------	--------	----------	-----

\*All support gables are drilled non-handed for left and right connection\*



24"D End Gable

ACC-FCG24	142	24/610	1/25	28/711	0.5/0.01	16/7
-----------	-----	--------	------	--------	----------	------

\*All support gables are drilled non-handed for left and right connection\*



30"D End Gable

ACC-FCG30	156	30/762	1/25	28/711	0.5/0.01	20/9
-----------	-----	--------	------	--------	----------	------

\*All support gables are drilled non-handed for left and right connection\*

Extended Gables



LEFT

Extended gable for increased privacy. Available on left or right. Gable length refers to overall gable length (desk depth + extension). 3in wide ledge over portion of gable that extends past desk worksurface.



RIGHT

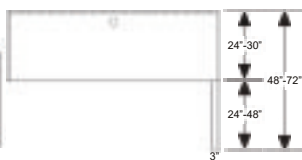

EXT48-L	551	48/1219	3/76	29/737	2.5/0.07	38/17
EXT54-L	571	54/1372	3/76	29/737	2.8/0.08	43/20
EXT60-L	594	60/1524	3/76	29/737	3.0/0.08	48/22
EXT66-L	617	66/1676	3/76	29/737	3.3/0.09	53/24
EXT72-L	640	72/1829	3/76	29/737	3.6/0.10	58/26
EXT48-R	551	48/1219	3/76	29/737	2.5/0.07	38/17
EXT54-R	571	54/1372	3/76	29/737	2.8/0.08	43/20
EXT60-R	594	60/1524	3/76	29/737	3.0/0.08	48/22
EXT66-R	617	66/1676	3/76	29/737	3.3/0.09	53/24
EXT72-R	640	72/1829	3/76	29/737	3.6/0.10	58/26

Drawing must be provided at time of order.



Optional three inch wide ledge allows for addition of privacy panel. Refer to pages 102-105 for options.





For additional specification instructions see pages 6-7.









		WIDTH	DEPTH	HEIGHT	VOLUME	WEIGHT
CODE	PRICE	(in/mm)	(in/mm)	(in/mm)	(ft <sup>3</sup> /m <sup>3</sup> )	(lbs/kg)
 <p>Pullout keyboard. Available in matching wood finish.</p>	ACC-22KB	148	22/559	12/305	3.5/89	1/0.03 12/5
	ACC-28KB	212	28/711	12/305	3.5/89	1/0.03 15/7
 <p>Polymer tray pullout keyboard. Black finish only.</p>	ACC-PLKB	287	21/533	10.5/267	3.5/89	2/0.06 16/7
 <p>Articulating keyboard with 20in (508mm) platform. Black finish. Includes gel wrist support.</p>	ACC-ARKB	624	21/533	10.5/267	3.5/89	2/0.06 14/6
 <p>Articulating keyboard with 20in (508mm) platform. Black finish. Includes gel wrist support, mouse support.</p>	ACC-ARKB-PRMS	683	28/711	10.5/267	3.5/89	2/0.06 16/7
 <p>Articulating keyboard with 28in (711mm) platform. Black finish. Includes gel wrist support.</p>	ACC-ARKB-28	719	30/762	10.5/267	3.5/89	2/0.06 16/7

For additional specification instructions see pages 6-7.



Premium Sit/Stand Articulating Keyboard with 20in (508mm) platform. Black finish. Includes get wrist support.

CODE	PRICE	WIDTH (in/mm)	DEPTH (in/mm)	HEIGHT (in/mm)	VOLUME (ft <sup>3</sup> /m <sup>3</sup> )	WEIGHT (lbs/kg)
ACC-ARKB-SS *	800	20/508	10.5/267	3.5/89	1/0.03	16/7



Premium Sit/Stand Articulating Keyboard with 28in (711mm) platform. Black finish. Includes get wrist support.

ACC-ARKB-28-SS *	888	28/711	10.5/267	3.5/89	1/0.03	18/8
------------------	-----	--------	----------	--------	--------	------

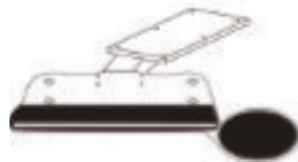

Premium Sit/Stand Articulating Keyboard with 20in (508mm) platform. Black finish. Includes get wrist support, mouse support.

ACC-ARKB-PRMS-SS **	852	30/762	10.5/267	3.5/89	2/0.06	17/8
---------------------	-----	--------	----------	--------	--------	------

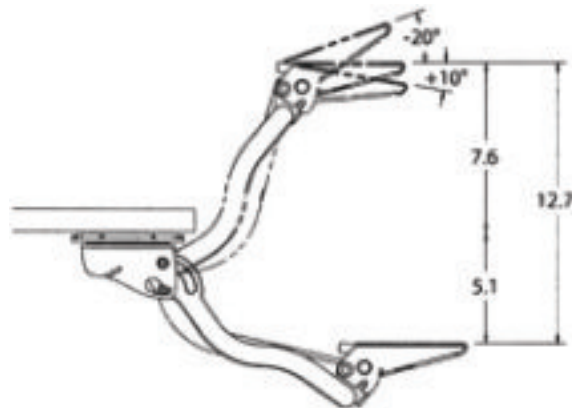

- \* Premium Sit/Stand Articulating Keyboard with Platform
- \*\* Premium Sit/Stand Articulating Keyboard with Platform and Mouse Support

Work in either "sitting" or "standing" position. Simply raise up to 7in (178mm) above worksurface, or down to 5.5in (140mm) below worksurface. Keyboard height adjusts by lift and release, to lock in place. Keyboard platform tilts +10/-20 degrees to create proper keyboard position. Rotating phenolic keyboard platform includes gel wrist support. Keyboard is mounted on a longer, smooth-rolling 23in (584mm) ball bearing track for extra stability during use. Allows for use in Radius Corner applications. Mouse tray includes Mouse Catcher. Mouse tray mounts on right or left side of keyboard platform or stows underneath when not in use.

For additional specification instructions see pages 6-7.

			WIDTH	DEPTH	HEIGHT	VOLUME	WEIGHT	
		CODE	PRICE	(in/mm)	(in/mm)	(in/mm)	(ft <sup>3</sup> /m <sup>3</sup> )	(lbs/kg)
	Polymer tray center drawer. Black finish.	ACC-PLCD	287	22/559	16/406	2/51	2/0.06	6/3
	Center drawer. Available in matching finishes.	ACC-LCD	149	21/533	14.5/368	3.5/89	1/0.03	12/5
	Mobile CPU dolly. Available in matching finishes.	ACC-1018-CPUM	151	10/254	18/457	3.5/89	2/0.06	6/3
	Optional Grommet. Add <b>(-BK)</b> for Black, <b>(-AL)</b> for Silver Specify installed position. See specifications page 133.	ACC-OG-FA ACC-OG-FI	56 29	Factory Installed Optional Grommet - Field Installed				
	PC caddy.	ACC-PCC	527					
	Paper Slot. Black Finish Specify installed position. See specifications pages 132-133.	ACC-PSL	151	17/432	1.5/38	1/25		
	CD holder accomodates 15 CD's.	ACC-LCDH	59	2.5/64	11.5/292	1/25		
	Task Light. Attaches under hutch units. Silver finish.	ACC-LTL24 ACC-LTL36	362 420	24/610 36/914	4/102 4/102	1.5/38 1.5/38	0.5/0.01 0.5/0.01	3/1 3/1

For additional specification instructions see pages 6-7.  
See page 133 for grommet placement options.

		WIDTH	DEPTH	HEIGHT	VOLUME	WEIGHT
CODE	PRICE	(in/mm)	(in/mm)	(in/mm)	(ft <sup>3</sup> /m <sup>3</sup> )	(lbs/kg)
 <p>Visual presentation cabinet with white board. Includes tackboard, four dry-erase markers and eraser with flip chart pad.</p>	CAB-4848-PC	1475	48/1219	5/127	48/1219	7/0.2 110/50
 <p>Pull down / retractable white colour projection screen. Fits CAB-4848-PC.</p>	ACC-0046-LAVS	340	46/1168	3/76	3/76	2/0.06 15/7
 <p>Flip Chart Pad 20"x30" lecture pads. 50 sheets per pad, 5 pads per carton (Price is per carton).</p>	ACC-2030-FCP	380	20/508	1/25	30/762	2/0.06 20/9
 <p>Wire Management Channel</p>	ELE-WM	16	per/ft	Please specify length required when ordering		
 <p>Wire management U-box cable holder for screwing to a worksurface.</p>	ELE-WM12-BK	125	12/305	5/127	3.5/89	1/0.03 3/1
 <p>Cable management spine. Add <b>(-BK)</b> for Black, <b>(-SL)</b> for Silver</p>	ELE-AHWM	217	6/152	6/152	1/0.03	5/2
 <p>Lock core kit. Includes: 1 core, 2 keys, 1 core removable key and installation instructions.</p>	ACC-LLCK	37	When placing order, indicate number of cores to be supplied with the same key number.			
 <p>Removes Core when lock is in "open" position only.</p>			Add <b>(-BK)</b> for Black, <b>(-SL)</b> for Silver			
 <p>Master Key (Smart Key). "One Key System" Smart Key will open all Links products with one master key.</p>	ACC-LMSK	37	Available to all authorized dealers only.			

For additional specification instructions see pages 6-7.



J Channel Assembly  
Single sided data ready quad power bar. Four knockouts for data jacks.

Available in **(-BK)** Black or **(-SL)** Silver Finish.



J Channel Assembly  
Double sided data ready quad power bar. Four knockouts for data jacks each side.

Available in **(-BK)** Black or **(-SL)** Silver Finish.



72"

Base Feed Hardware.  
Most common solution to wiring Links Pak 8 to the building wiring. Requires licensed electrician.

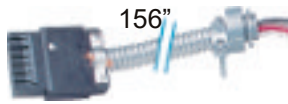

156"

Ceiling Feed Hardware  
Used to introduce power to the first power module from a ceiling power pole source. Requires a licensed electrician.



Metal Flex Cable Female both ends.

Connects from power module to power module.



Metal Flex Cable Female/Male

Used in directional systems as an extension cable or pass through from female cable to power module.

CODE	PRICE	WIDTH (in/mm)	DEPTH (in/mm)	HEIGHT (in/mm)	VOLUME (ft3/m3)	WEIGHT (lbs/kg)
------	-------	------------------	------------------	-------------------	--------------------	--------------------

ELE-JCA-8-SGL	433	10.44/265	1.56/40	4.5/114		
---------------	-----	-----------	---------	---------	--	--

ELE-JCA-8-DBL	494	10.44/265	2.5/64	4.5/114		
---------------	-----	-----------	--------	---------	--	--

ELE-BFH-8	250	75/1905				
-----------	-----	---------	--	--	--	--

ELE-CFH-8	370	156/3962				
-----------	-----	----------	--	--	--	--

ELE-0024-FF-8	161	24/610				
ELE-0036-FF-8	191	36/914				
ELE-0042-FF-8	208	42/1067				
ELE-0048-FF-8	220	48/1219				
ELE-0060-FF-8	248	60/1524				
ELE-0072-FF-8	276	72/1829				
ELE-0084-FF-8	302	84/2134				
ELE-0096-FF-8	332	96/2438				

ELE-0024-FM-8	161	24/610				
ELE-0036-FM-8	191	36/914				
ELE-0042-FM-8	208	42/1067				
ELE-0048-FM-8	220	48/1219				
ELE-0060-FM-8	248	60/1524				
ELE-0072-FM-8	276	72/1829				
ELE-0084-FM-8	302	84/2134				
ELE-0096-FM-8	332	96/2438				

For additional specification instructions see pages 6-7.



			WIDTH	DEPTH	HEIGHT	VOLUME	WEIGHT	
		CODE	PRICE	(in/mm)	(in/mm)	(in/mm)	(ft3/m3)	(lbs/kg)
	Optional communication plugs. RJ11/RJ45	ELE-CP-8	160					
	Extra simplex receptacles. ELE-SI1, ELE-SI2 have black covers. ELE-SIG has an orange cover.	ELE-SI1-8 ELE-SI2-8 ELE-SIG-8	25 25 28					
	Simplex remover tool. Proper tool for safe removal of simplex receptacles.	ELE-SRT	23					
	Power Center. Plastic 2 power, 2 knockouts  Available in <b>(-BK)</b> Black or <b>(-WH)</b> White Finish.  Specify position - see page 132.	ELE-PORT-400	433				Please specify position when ordering.	
	Power/Data Center. Metal 2 power, 2 knockouts (jacks not included)  Available in <b>(-SL)</b> Silver or <b>(-BK)</b> Black Finish.  Specify position - see page 132.	ELE-PORT-200	722				Please specify position when ordering.	
	Retractable power center, factory installed only.  Specify position - see pages 132-133.	ELE-RPC	380				Please specify position when ordering.	
	Retractable power/communication center, factory installed.  Specify position - see pages 132-133.	ELE-RPCD	475					

For additional specification instructions see pages 6-7.  
See pages 132-133 for power/data center, grommet placement options.

**ELE-PORT**

**Power/Data Center**

The ELE-PORT is a compact workspace accessory that provides convenient power and data distribution.

**Item Codes:**

ELE-PORT-400 (Black or White) and ELE-PORT-200 (Black or Silver)

**Standard Features:**

- 2 simplexes
- 2 voice/data ports/housing (jacks not included)
- 15 amp cord
- UL listed
- Voice/data adapter kits are standard, accept couplers and jacks.
- Worksurface cutouts included in standard locations.

**ELE-PORT Voice/DATA Adapter Kit**

- One voice/data kit is supplied with each ELE-PORT.
- Adapters made to accept most couplers and jacks.

**ELE-PORT Specifications:**

- ELE-PORT may be ordered on all worksurfaces.
- 10 foot black cord included.
- ELE-PORTs are available in standard worksurface locations (shown below)
- ELE-PORTs may be placed in custom locations, a drawing is required indicating exact vertical and horizontal locations for the **center of the cutout**.



(Black)



(Silver)

**Returns / Connecting Tops**  
Standard POS2



(on most worksurfaces)

**Shaped Tables**

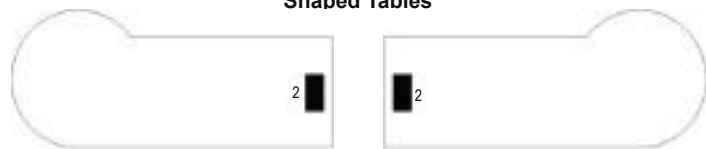

**Corner Units / VTI**

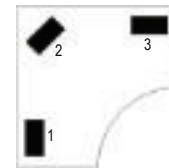

**Extended Corner Units**

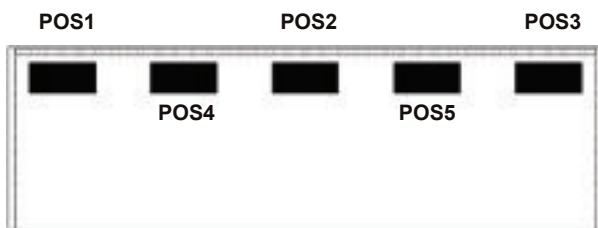

Cut-out placed on user side of back panel.

**ELE-PORT Position Codes**

- POS1** Left/Left User Side
- POS2** Center/Center User Side
- POS3** Right/Right User Side
- POS4** Left/Center User Side
- POS5** Right/Center User Side



See power distribution components on page 130 for pricing.

**Grommets**

- Additional grommets are available in standard locations (see below).
- Grommets may be placed in custom locations, a drawing is required indicating exact locations.
- For units that include standard grommets, to replace black grommet with silver grommet add OG-SL to end of product code.

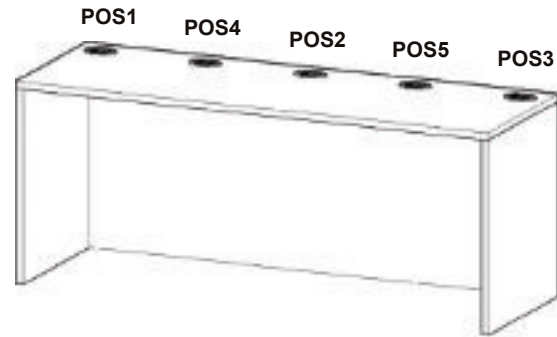

**ACC-OG-BK**  
**Black Grommet**  
(Standard)

**Black Grommet (OG-BK) Position Codes**

- POS1** Left/Left User Side
- POS2** Center/Center User Side
- POS3** Right/Right User Side
- POS4** Left/Center User Side
- POS5** Right/Center User Side



**ACC-OG-SL**  
**Silver Grommet**  
(Optional)

**Silver Grommet (OG-SL) Position Codes**

- POS1** Left/Left User Side
- POS2** Center/Center User Side
- POS3** Right/Right User Side
- POS4** Left/Center User Side
- POS5** Right/Center User Side

**Returns / Connecting Tops**  
Standard POS2

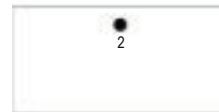

(on most worksurfaces)

**Shaped Tables**

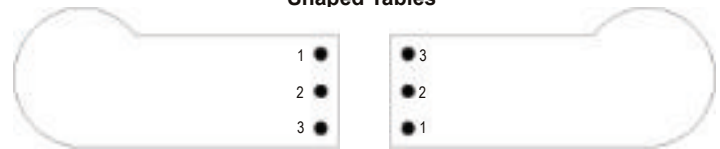

**Corner Units / VTI**

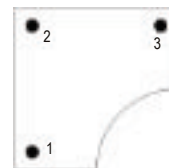

**Extended Corner Units**

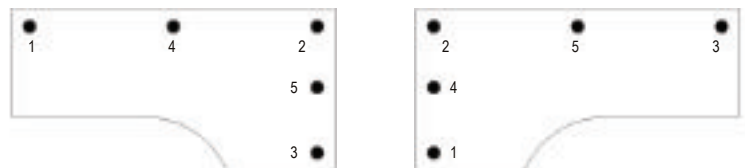

**Locks**

- Locks are standard with interchangeable lock cores and collapsible keys. Keys supplied with Microban Antimicrobial product protection.
- Locks are standard black finish, to change locks to silver finish specify "silver locks" at time of order.
- Specify "keyed alike" where applicable.



**Black Lock**  
(Standard)



**Silver Lock**  
(Optional)

See accessories on page 128 for pricing.



**prices**

Prices are F.O.B. at our point of distribution in the USA and Canada, and are subject to change without notice. All merchandise will be invoiced at prices prevailing at time of shipment. Applicable taxes are extra.

**terms**

C.O.D. unless credit has been established. All merchandise will be invoiced at the time of shipment and payment is due 30 days following the date of the invoice. 2% interest per month will be charged on overdue accounts.

**claims**

Links Contract Furniture Inc. will not be responsible for damages which occur during storage or transit. All shipments should be carefully examined before being accepted from carrier as our liability ends when carrier signs our delivery slip acknowledging that the merchandise has been received in good condition. Claims for damages must be filed with the carrier within 5 days of receiving merchandise.

**changes**

Links Contract Furniture Inc. reserves the right to make improvements and/or changes in prices, design, material and packaging without prior notice.

**shipping**

Please specify carrier choice on your purchase order, otherwise carrier will be selected by Links Contract Furniture Inc.

**returns**

No returns will be accepted without prior written authorization. "Express" item returns are subject to a minimum 15% re-stocking charge and all other items are subject to a minimum 25% re-stocking and handling charge. No refunds will be made on special custom orders of any kind.

**cancellations**

Cancellations are subject to a 25% expense recovery charge. No cancellations will be accepted on special orders.

**special orders**

A detailed purchase order must accompany all special orders. It must include a clear sketch of all sizes and finishes of each unit, with a customer signature of approval.

**orders**

To avoid errors, we request that all purchases be confirmed in writing. Specify model numbers and finishes. Links Contract Furniture Inc. will not be responsible for errors unless orders are supported by a written confirmation.

**sizes**

All sizes, as specified, are approximate. Exact dimensions will be provided upon request.

Links Contract Furniture is a manufacturer of high quality office furniture with experience in creating high performance workplace environments that have inspired, challenged, and adapted to the changing needs of its consumers since 1995. At Links Contract Furniture we embrace research and design - bringing innovative ideas, products, and services to the North American office furniture market.

**Ami Spector**

**President**





### **Links Contract Furniture Product Solutions**

Links Contract Furniture creates products with a full range of design specifications. Our commitment as an organization is to design, manufacture, and deliver innovative, high quality, and environmentally friendly product solutions. Links Contract Furniture also believes in contributing to health and wellness in the workplace and, therefore, offers a broad line of ergonomic solutions.

### **Links Contract Furniture Processes Examples:**

- Verifying incoming component parts against a master component part to ensure consistency of quality and finishes.
- Using the latest in automated manufacturing machinery, ensuring product consistency and accuracy. Ongoing calibration of machinery is conducted to ensure product accuracy is always maintained.
- Product labels are placed on finished products allowing for post-purchase inquiries and product part identification.



### **A Dedication to Sustainable Design**

Through every step in our products' life cycles we consider our environmental impact, in order to act on opportunities to develop increasingly sustainable practices and designs. Behind the scenes, Links Contract Furniture employees work hard to attain environmental performance goals, such as generating low emitting office furniture systems and leveraging natural resources in product development, and cultivating a zero tolerance atmosphere for damaging ecosystem health. Links Contract Furniture goes above and beyond by not only monitoring its own environmental impact but also the impact of its many supplier groups. Links utilizes environmentally preferred products within its manufacturing processes in order to reduce the overall environmental impact of product creation from start to finish.

### **A Dedication to Growth**

Links Contract Furniture is engaged in continuous development in order to meet the growing requirements of the marketplace. We observe a commitment to design, excellence, and innovation; leveraging our dedicated professionals to offer real world solutions for an ever-changing business environment.



## Links Contract Furniture Values

We value our customers. We are responsible to the consumers who use our products. Therefore, in meeting the needs of our consumers we are committed to delivering the upmost quality products and providing business excellence as the base of everything we do. We promise to listen closely to the needs of our consumers and strive to continuously exceed expectations.

At Links we recognize our members. An organization is only effective as its people. Therefore, employee development is an essential element of company growth. As an organization we believe in the ability of our people and stand behind them in achieving their greatest potential.

We value integrity. We believe in developing integrity in the deepest layers of our organization and not just at its surface. We strive to build mutually beneficial relationships with our customers, dealers, and suppliers as a foundation for growth.

We value continuous learning. We believe in growth through experience. A constant evolution in the way we think and act brings about new knowledge and skills that allow us to develop improved processes, advanced designs, and reduce our environmental impact.

We value our world. We work to cultivate the world in which we live in through investing in our people and the pursuit of sustainable development. Focusing our value chain on the challenges of sustainable development has allowed us to find new ways to minimize our impact on the environment.







LINKS' Creative Solutions . . . The Industry Leader!



Quality Office Furniture. Products meet or exceed ANSI/BIFMA x 5.5-2008 Quality Standards, Greenguard Certified.

While every effort is made to ensure the accuracy of information contained in this price list at the time of publication, we cannot accept responsibility for inaccuracies resulting from printing errors or omissions. We reserve the right to make product improvements and price changes without notice.

© Copyright 2023 Links Contract Furniture Inc.. All Rights Reserved.

Head Office/Showroom: 141 Cidermill Ave, Unit #1 Concord, Ontario Canada L4K 4G5  
Local & International: P: 416.745.8910  
Toll Free - North America: P: 855-50-LINKS (855.505.4657)  
Email: info@linkscontract.com  
Website: linkscontract.com

